

Models ACF w/o Coil
ACW w/Hot Water Coil
ACE w/Electric Coil

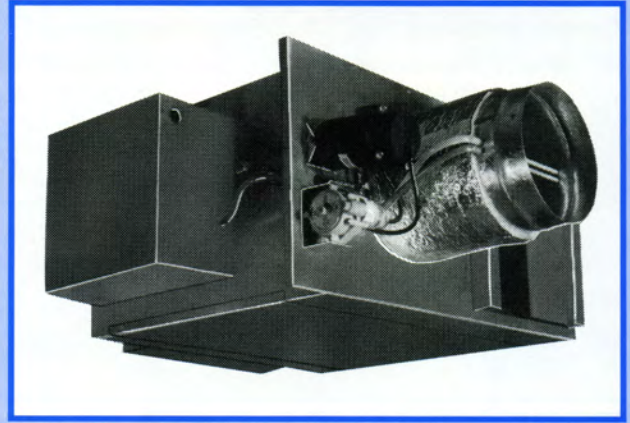

The **Carnes** constant volume fan terminal unit provides constant air volume to the space while retaining the advantages of a variable air volume system.

The primary air control assembly operates in the same manner as a standard throttling control valve when cooling loads are high. As cooling loads diminish the integral blower(s) induces warm ceiling plenum air to maintain constant air volume.

Other Features Include:

- Air flow capacities to 2850 CFM.
- Durable 22 gauge galvanized steel casing construction.
- Access panel for internal components.
- Standard inlet sizes and slip and drive discharge connections.
- Forward curved centrifugal type fan assemblies with thermally protected, permanent split capacitor type 115 or 277 volt, single phase, fractional horsepower three speed motors.
- Field adjustable fan air flow damper (between three speeds).
- Fan/motor assemblies are isolated from the casing using rubber isolators to minimize vibration transmission.
- Low leakage primary air damper design.
- Secondary air filter rack.
- Performance data based on tests conducted in accordance with ARI Standard 880-94.
- Air flow switch.
- All units are equipped with pressure independent pneumatic or electronic controls.
- Field adjustable P/E switch with pneumatic controls.
- Averaging type velocity sensor and calibration chart for measuring air flow through the primary air damper.
- Insulation is 1" thick, 1-1/2 lb. dual density fiberglass with surface treated to prevent air erosion, UL listed and meets NFPA 90A requirements.
- Optional ETL listing.
- Optional fan speed selector switch.
- Optional primary air controls enclosure.
- Optional one or two row hot water coils (Model ACW). Coil is factory attached to the unit discharge.
- Optional one, two or three stage electric reheat coils (Model ACE). Coil is factory attached to unit discharge or shipped separately for field mounting.
- Optional secondary air filters, Class I (re-usable) or Class II (throw away).
- Optional quick release access panel.
- Optional foil coated insulation (Hospital, Laboratory, etc. applications).

Available Modules:

- Basic control unit — **Model ACF.**
- Basic control unit with hot water coil — **Model ACW.**
- Basic control unit with electric coil — **Model ACE.**

Typical Sequence of Operation

Central fan on — Day (occupied) operation.

When the central system fan is "on" and a positive pressure of at least .10 IWC is present at the primary air inlet, the unit air flow switch senses this pressure and keeps the fan on all the time by overriding the unit P/E switch action with pneumatic controls or electric contactor with electronic controls.

Central fan off — Night (unoccupied) operation.

When the central system fan is "off" at 0.0 to negative pressure is present at the primary air inlet. The air flow switch senses the negative pressure and is taken out of the circuit. The unit fan is then turned off by the P/E switch with pneumatic controls or electric contactor with electronic controls.

CAUTION: For electronically controlled units, a minimum CFM value other than zero may cause the damper to drive open when the central system is off.

PERFORMANCE DATA — Constant Volume Fan Terminal Units

Fan Unit Model	Unit Size	Motor(s) H. P.	120 Volt Motor(s) FLA	277 Volt Motor(s) FLA
AC	06	1 @ 1/6	2.0	.8
AC	07	1 @ 1/6	2.0	.8
AC	08	1 @ 1/5	2.2	.9
AC	10	1 @ 1/4	3.2	1.2
AC	12	1 @ 1/2	6.2	2.3
AC	14	2 @ 1/4	6.4	2.4
AC	16	2 @ 1/2	12.4	4.6

FAN CURVES CFM vs External Static Pressure

Models AC 06 & AC 07

1/6 H. P. Motor

F. L. A.: 2.0A @ 120V .8A @ 277 V

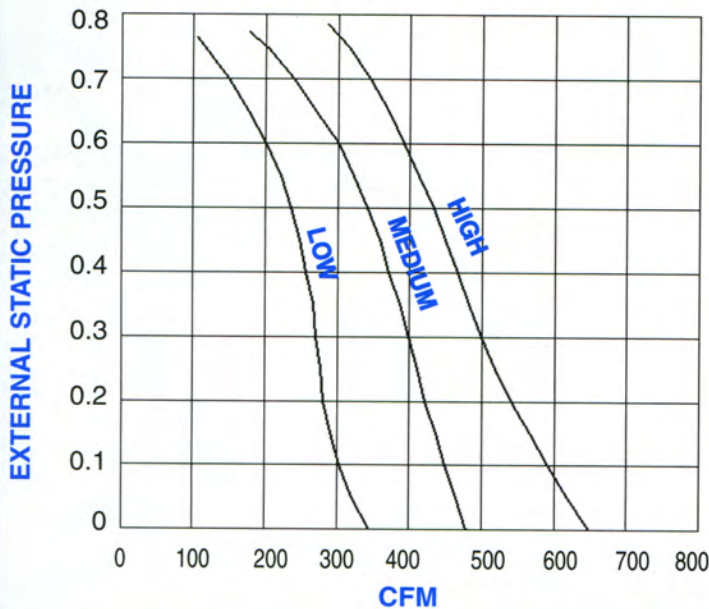

Model AC 08

1/5 H. P. Motor

F. L. A.: 2.2A @ 120V .9A @ 277 V

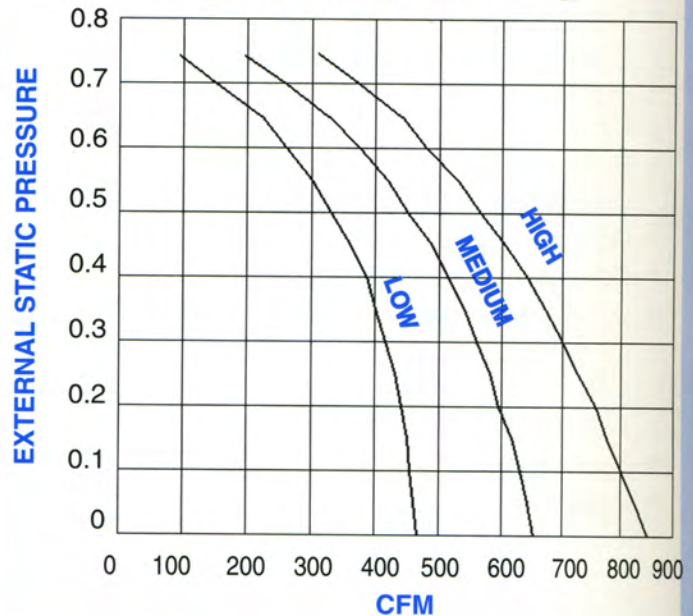

- NOTES:**
1. External static pressure (ESP) consist of downstream ductwork, coils, flex duct, etc.
 2. Pressure drops due to heating coils are treated as external static pressures (Refer to coil sections of this catalog for additional information.)
 3. F. L. A. = Full Load Amps of motor.

FAN CURVES CFM vs External Static Pressure

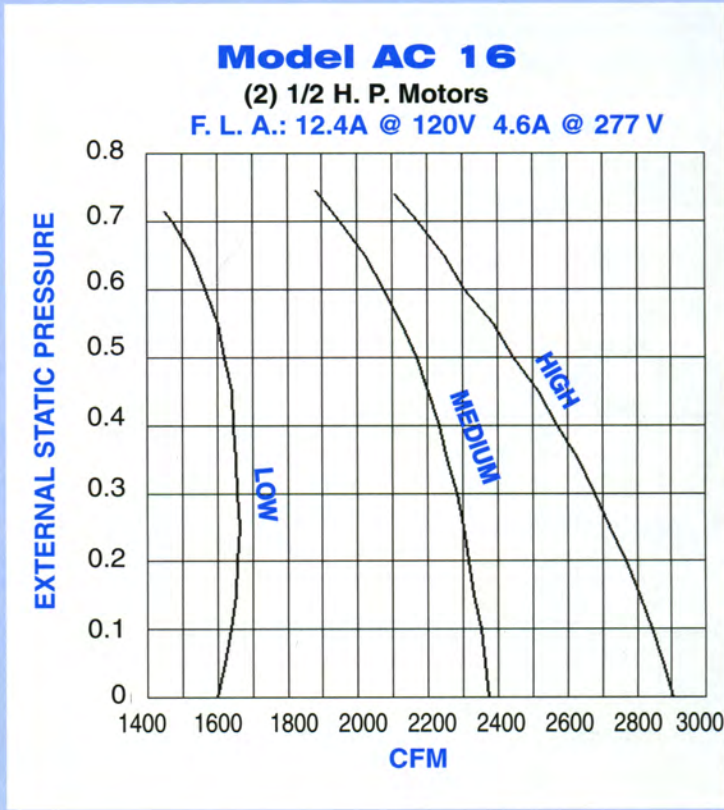
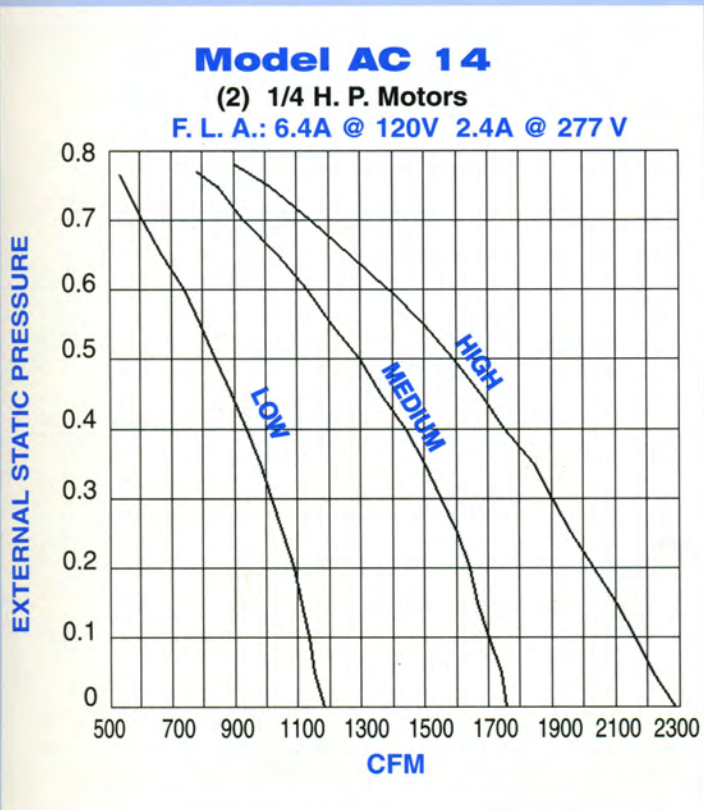
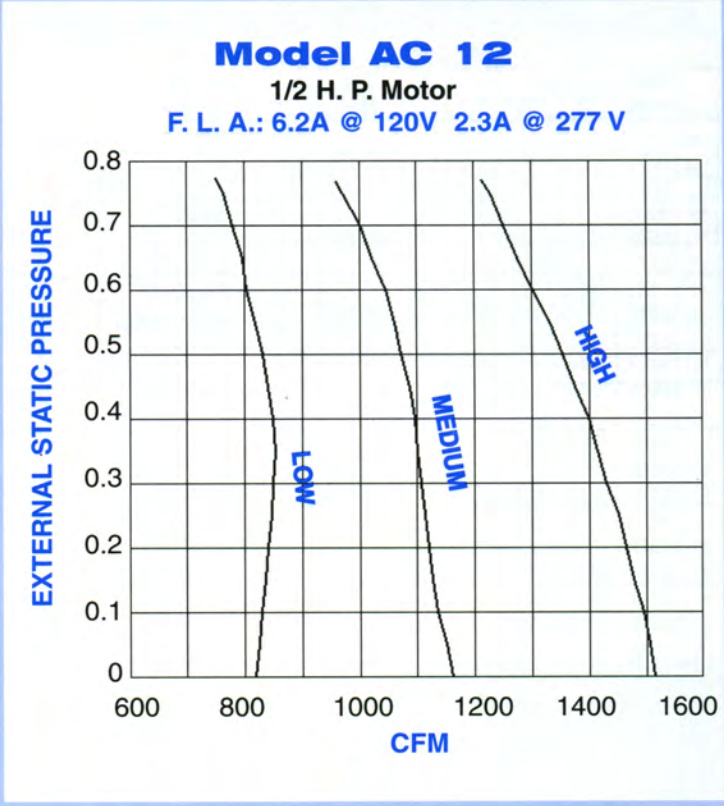
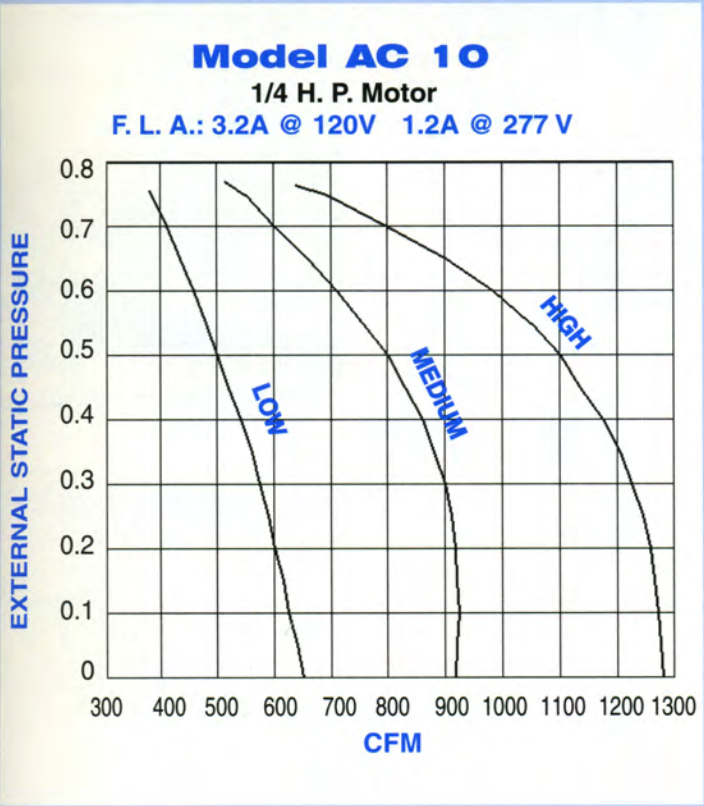

- NOTES:**
1. External static pressure (ESP) consist of downstream ductwork, coils, flex duct, etc.
 2. Pressure drops due to heating coils are treated as external static pressures (Refer to coil sections of this catalog for additional information.)
 3. F. L. A. = Full Load Amps of motor.

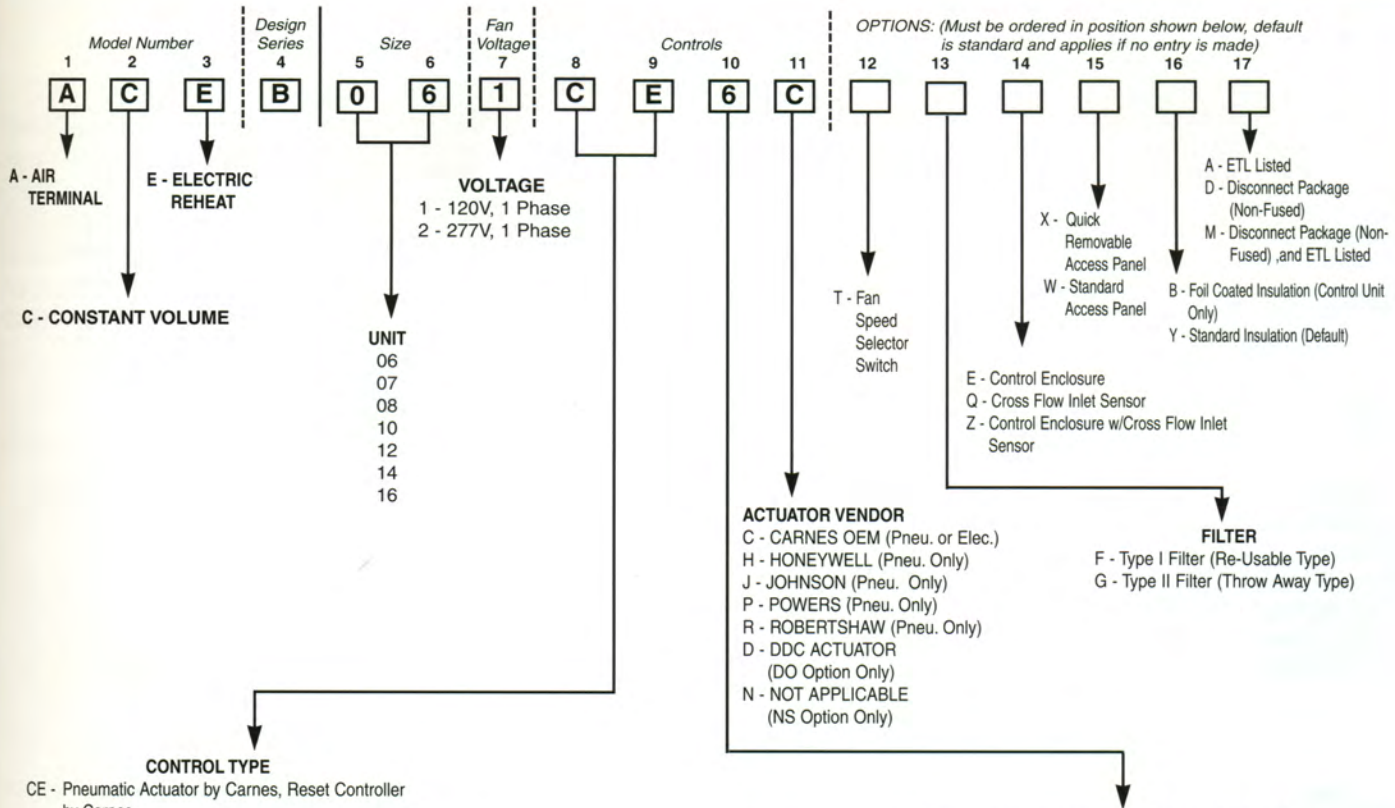

CONTROL TYPE

- CE - Pneumatic Actuator by Carnes, Reset Controller by Carnes
- CX - Pneumatic Actuator by Carnes, (Multi-function) Reset Controller by Carnes
- PE - Pneumatic Actuator by Others, Mounted by Carnes, Reset Controller by Carnes
- PX - Pneumatic Actuator by Others, Mounted by Carnes, (Multi-function) Reset Controller by Carnes
- ET - Analog Electronic Velocity Controller with Integral Damper Actuator
- DO - DDC Provided by Others, Mounted and Wired by Carnes, with Carnes Inlet Sensor, with 3/8" Damper Shaft
- NS - No Damper Controls, with Carnes Inlet Sensor, with bare 3/8" Damper Shaft
- NA - No Damper Controls with Carnes Inlet Sensor, with Pneumatic Actuator Linkage (Must Specify Vendor)

NOTE: Hand of controls is determined by facing the averaging flow sensor (inlet of the unit) with the supply air hitting the back of your head.

CONTROLS, DAMPER AND COIL ARRANGEMENTS

- *1 - Normally Open - Right Hand Controls and Coil Control Panel (Electronic/DO, NS, NA)
(All Pneumatic Control Types for Reverse Acting Thermostat)
- *2 - Normally Open - Left Hand Controls and Coil Control Panel (Electronic/DO, NS, NA)
(All Pneumatic Control Types for Reverse Acting Thermostat)
- 3 - Normally Closed - Right Hand Controls and Coil Control Panel (All Pneumatic Control Types for Direct Acting Thermostat)
- 4 - Normally Closed - Left Hand Controls and Coil Control Panel (All Pneumatic Control Types for Direct Acting Thermostat)
- 5 - Normally Open - Right Hand Controls and Coil Control Panel (All Pneumatic Control Types for Direct Acting Thermostat)
- 6 - Normally Open - Left Hand Controls and Coil Control Panel (All Pneumatic Control Types for Direct Acting Thermostat)
- 7 - Normally Closed - Right Hand Controls and Coil Control Panel (All Pneumatic Control Types for Reverse Acting Thermostat)
- 8 - Normally Closed - Left Hand Controls and Coil Control Panel (All Pneumatic Control Types for Reverse Acting Thermostat)

A Carnes Electronic Thermostat **must be ordered** with the Electronic ET Control Option.

*Electronic and DDC Units DO NOT Fail Open. "1" or "2" is used for Model Numbering Only. Electronic Units are shipped with the Damper in Closed Position. (Refer to the Controls Catalog AV-02 for additional operating information.)

- LEFT HAND PRIMARY AIR UNIT SHOWN. RIGHT HAND AVAILABLE
- PRIMARY AIR AND COIL CONTROL PANEL MUST BE ON SAME SIDE OF UNIT
- ELECTRIC COIL SHOWN ATTACHED, COIL SHIPPED SEPARATE FROM TERMINAL UNIT AS STANDARD

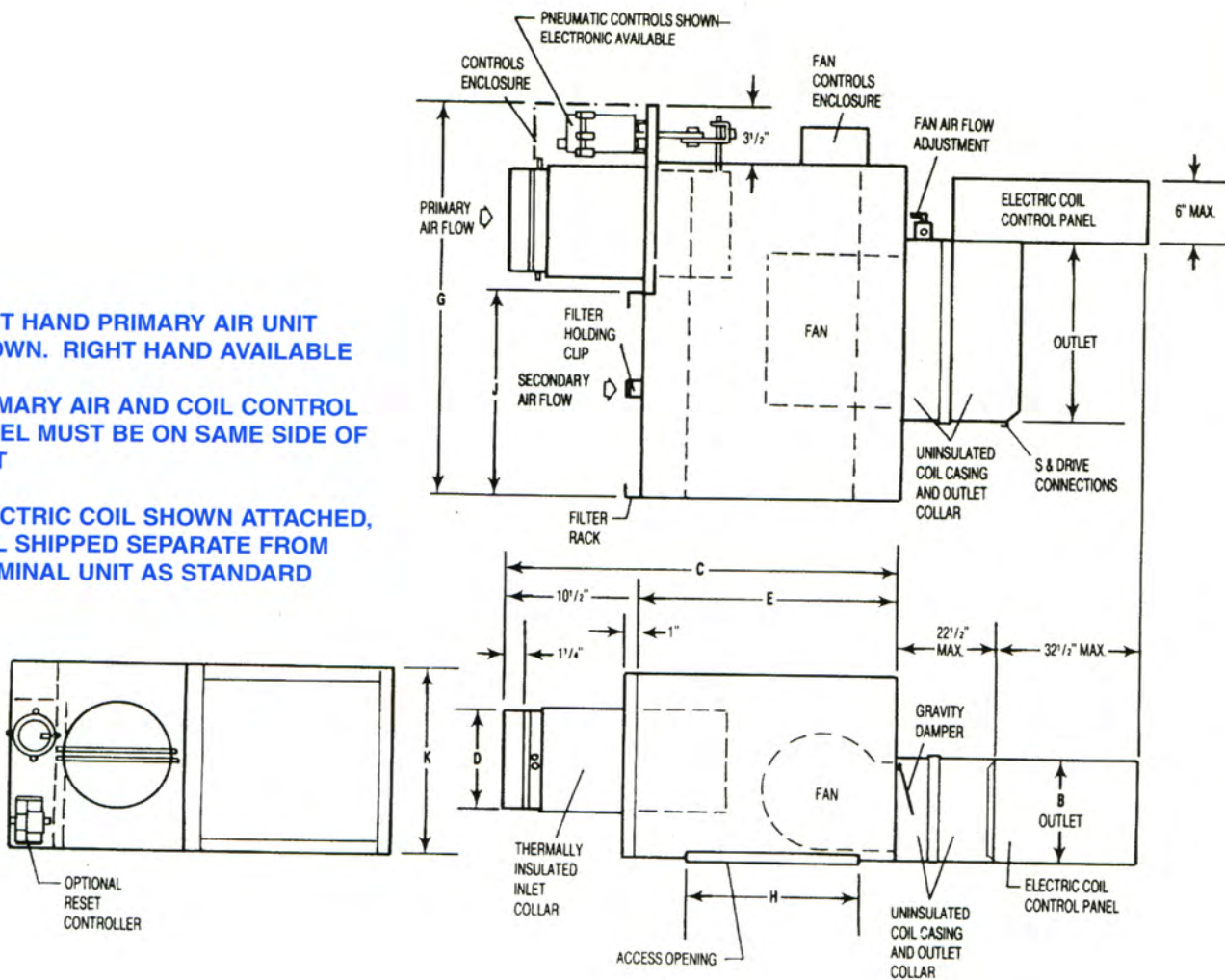

DIMENSIONS LISTED IN INCHES

Unit Size	*Primary Nominal CFM	Nominal Fan CFM @ .10" E.S.P.	Fan H. P.	S & Drive Outlet		C	Inlet		E	G	H	Secondary Air Inlet	
				A	B		D	J				K	
06	500	580	1/6	14	10	31	5-7/8	20-1/2	29-1/2	13-1/2	12	14	
07	580	580	1/6	14	10	31	6-7/8	20-1/2	29-1/2	13-1/2	12	14	
08	800	800	1/5	14	10	31	7-7/8	20-1/2	29-1/2	13-1/2	12	14	
10	1250	1250	1/4	14	12-1/2	34-1/2	9-7/8	24	35-1/2	17	16	17-1/2	
12	1500	1500	1/2	16	15	34-1/2	11-7/8	24	35-1/2	17	16	17-1/2	
14	2100	2100	(2) 1/4	32	17-1/2	36-1/2	13-7/8	26	49-1/2	19	26	17-1/2	
16	2850	2850	(2) 1/2	32	17-1/2	36-1/2	15-7/8	26	49-1/2	19	26	17-1/2	

*Refer to "Primary Air Inlet Parameters" (page 6) when selecting MINIMUM and MAXIMUM CFM.

Models AC — L1, L2, L3 & L4

The **Carnes** low profile constant volume fan terminal unit provides constant air volume to the space while retaining the advantages of a variable air volume system.

The primary air control assembly operates in the same manner as a standard throttling control valve when cooling loads are high. As cooling loads diminish the integral blower(s) induces warm ceiling plenum air to maintain constant air volume.

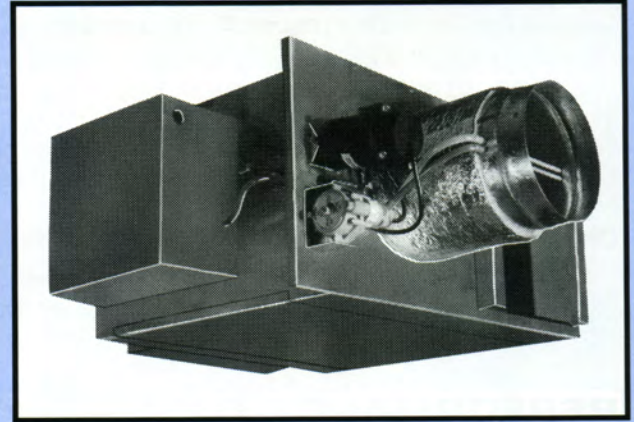

Other Features Include:

- Air flow capacities to 2000 CFM.
- A maximum unit height dimension of 11 inches.
- Durable 22 gauge galvanized steel casing construction.
- Access panel for internal components.
- Standard inlet sizes and slip and drive discharge connections.
- Forward curved centrifugal type fan assemblies with thermally protected, permanent split capacitor type 115 or 277 volt, single phase, fractional horsepower three speed motors.
- Field adjustable fan air flow damper (between three speeds).
- Low leakage primary air damper design.
- Secondary air filter rack.
- Performance data based on tests conducted in accordance with ARI Standard 880-94.
- Air flow switch.
- All units are equipped with pressure independent pneumatic or electronic controls.
- Field adjustable P/E switch with pneumatic controls.
- Averaging type velocity sensor and calibration chart for measuring air flow through the primary air damper.
- Insulation is 1/2" thick, 1-1/2 lb. dual density fiberglass with surface treated to prevent air erosion, UL listed and meets NFPA 90A requirements.
- Optional fan speed selector switch.
- Optional primary air controls enclosure.
- Optional one or two row hot water coils (Model ACW). Coil is factory attached to the unit discharge.
- Optional electric reheat coils (Model ACE). Coil is factory attached to unit discharge or shipped separately for field mounting.
- Optional secondary air filters, Class I (re-usable) or Class II (throw away).
- Optional foil coated insulation (Hospital, Laboratory, etc. applications).
- Optional ETL listing.

Available Modules:

- Basic control unit — **Model ACF.**
- Basic control unit with hot water coil — **Model ACW.**
- Basic control unit with electric coil — **Model ACE.**

3 FAN TERMINAL UNITS — Constant Volume Low Profile (Series Flow)

Typical Sequence of Operation

Central fan on — Day (occupied) operation.

When the central system fan is "on" and a positive pressure of at least .10 IWC is present at the primary air inlet, the unit air flow switch senses this pressure and keeps the fan on all the time by overriding the unit P/E switch action with pneumatic controls or electric contactor with electronic controls.

Central fan off — Night (unoccupied) operation.

When the central system fan is "off" a 0.0 to negative pressure is present at the primary air inlet. The air flow switch

senses the negative pressure and is taken out of the circuit. The unit fan is then turned on and off by the P/E switch with pneumatic controls or electric contactor with electronic controls on a call for heat.

CAUTION: For electronically controlled units, a minimum CFM value other than zero may cause the damper to drive open when the central system is off.

PERFORMANCE DATA — Low Profile Constant Volume Fan Terminal Units

Motor Full Load Amp (FLA) Rating

Fan Unit Model	Unit Size	Motor(s) H. P.	120 Volt Motor(s) FLA	277 Volt Motor(s) FLA
AC	L1	1 @ 1/6	2.0	.8
AC	L2	1 @ 1/4	3.2	1.2
AC	L3	2 @ 1/6	4.0	1.6
AC	L4	2 @ 1/4	6.4	2.4

FAN CURVES — CFM vs External Static Pressure

Model AC — Size L1

1/6 H. P. Motor

F. L. A.: 2.0A @ 120V .8A @ 277 V

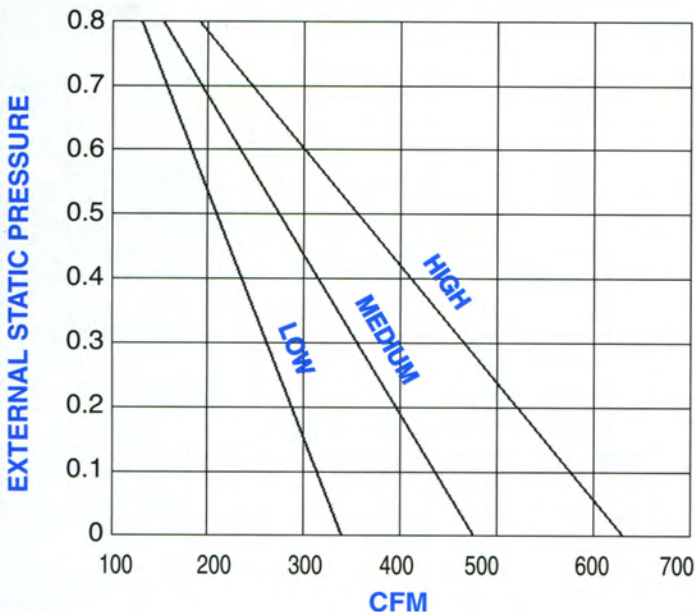

Model AC — Size L2

1/4 H. P. Motor

F. L. A.: 3.2A @ 120V 1.2A @ 277 V

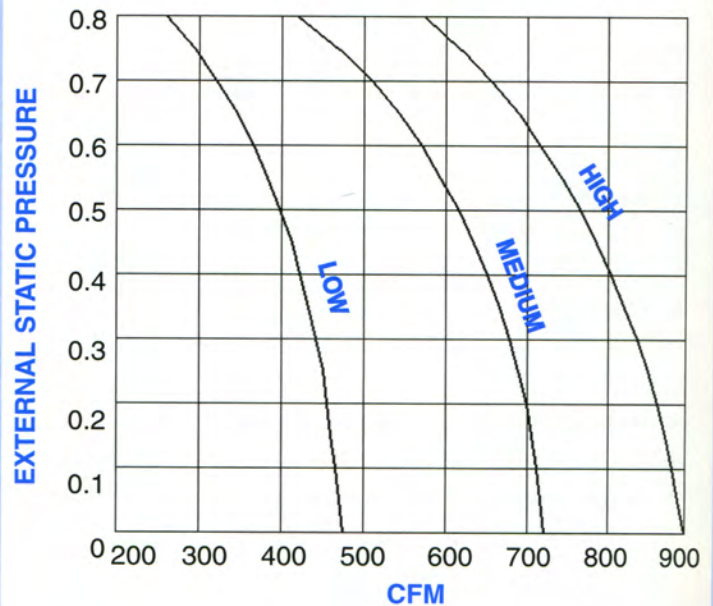

- NOTES:**
- External static pressure (ESP) consist of downstream ductwork, coils, flex duct, etc.
 - Pressure drops due to heating coils are treated as external static pressures (Refer to coil sections of this catalog for additional information.)
 - F. L. A. = Full Load Amps of motor.

FAN CURVES — CFM vs External Static Pressure

Model AC - Size L3

(2) 1/6 H. P. Motors

F. L. A.: 4.0A @ 120V 1.6A @ 277 V

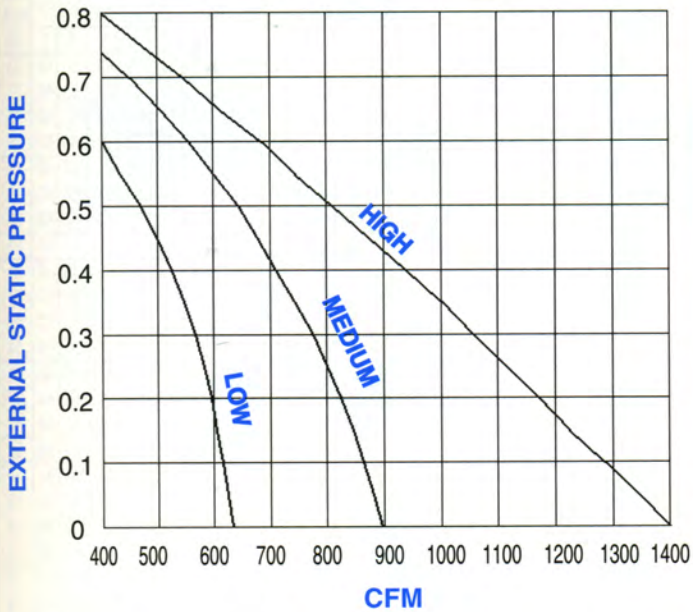

Model AC - Size L4

(2) 1/4 H. P. Motors

F. L. A.: 6.4A @ 120V 2.4A @ 277 V

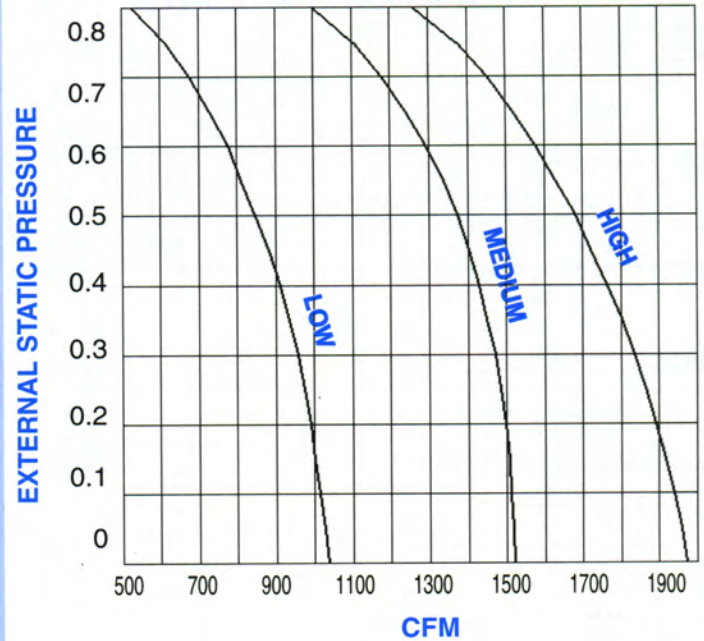

- NOTES:** 1. External static pressure (ESP) consists of downstream ductwork, coils, flex duct, etc.
 2. Pressure drops due to heating coils are treated as external static pressures (Refer to coil sections of this catalog for additional information.)
 3. F. L. A. = Full Load Amps of motor.

SOUND PERFORMANCE DATA — Low Profile Constant Volume Fan Terminal Units

(FAN ON - 100% Primary)

Fan Speed	ESP	Unit Size	Primary/Secondary CFM	Primary Air ΔP_s	Discharge NC	Radiated NC
HI	.25	L1	460/0	.12	22	20
MED	.25		370/0	.09	19	18
LO	.25		280/0	.07	21	17
HI	.25	L2	840/0	.13	21	23
MED	.25		680/0	.07	16	20
LO	.25		440/0	.05	14	14
HI	.25	L3	1100/0	.44	27	22
MED	.25		760/0	.14	18	22
LO	.25		560/0	.11	17	20
HI	.25	L4	1850/0	.98	17	27
MED	.25		1480/0	.66	15	23
LO	.25		960/0	.23	13	18

- NOTES:** 1. Performance data on this page is considered to be application data. Although this data is presented in a format that cannot be certified, it is based on testing in accordance with ARI Standard 880. Certified performance data is shown on page 71.
 2. ΔP_s is static pressure difference from inlet to discharge and does not include hot water or electric coils. (Refer to coil section of this catalog for pressure drop and performance information.)
 3. External Static Pressure (ESP) is pressure due to the air flow adjustment damper, heating coils, and/or downstream ductwork.
 4. The CFM indicated is the maximum attainable at the external static pressure (ESP) shown.

Discharge NC levels are based on:

- a) 5 foot rectangular 12" x 12" duct lined with 1" fiberglass insulation.
- b) Rectangular tee attenuation entering branch duct.
- c) 6 foot lined flex duct (8" diameter).
- d) Maximum of 300 CFM per outlet.
- e) Space effect factor (5000 ft³) at 5 feet from outlet.
- f) 10 db for room absorption.

Radiated NC levels are based on:

- a) Plenum/ceiling effect - 5/8" mineral fiber tile, 35 lb/ft³.
- 3 foot plenum
- b) Space effect factor (5000 ft³) at 10 feet from outlet.
- c) 10 db for room absorption.

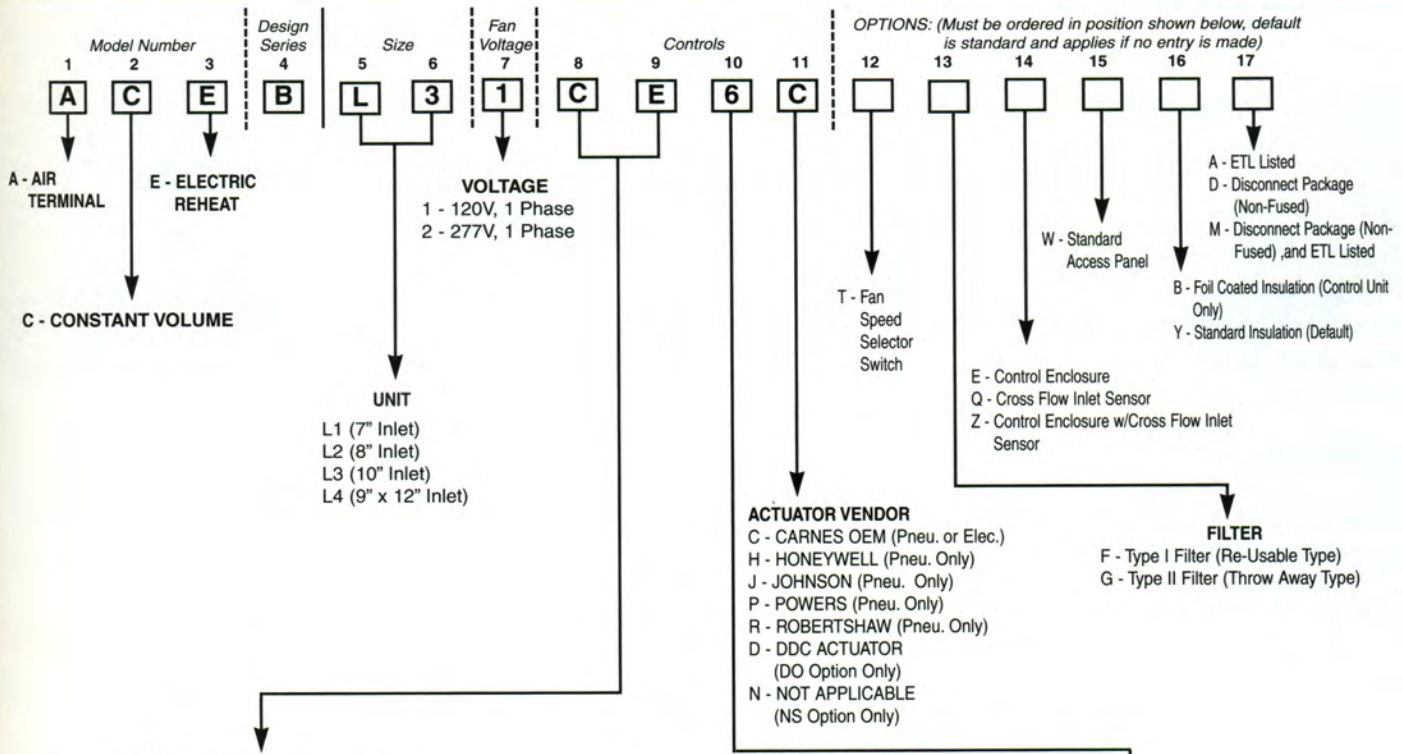

- CONTROL TYPE**
- CE - Pneumatic Actuator by Carnes, Reset Controller by Carnes
 - CX - Pneumatic Actuator by Carnes, (Multi-function) Reset Controller by Carnes
 - PE - Pneumatic Actuator by Others, Mounted by Carnes, Reset Controller by Carnes
 - PX - Pneumatic Actuator by Others, Mounted by Carnes, (Multi-function) Reset Controller by Carnes
 - ET - Analog Electronic Velocity Controller with Integral Damper Actuator
 - DO - DDC Provided by Others, Mounted and Wired by Carnes, with Carnes Inlet Sensor, with 3/8" Damper Shaft
 - NS - No Damper Controls, with Carnes Inlet Sensor, with bare 3/8" Damper Shaft
 - NA - No Damper Controls with Carnes Inlet Sensor, with Pneumatic Actuator Linkage (Must Specify Vendor)

A Carnes Electronic Thermostat **must be ordered** with the Electronic ET Control Option.

NOTE: Hand of controls is determined by facing the averaging flow sensor (inlet of the unit) with the supply air hitting the back of your head.

- ACTUATOR VENDOR**
- C - CARNES OEM (Pneu. or Elec.)
 - H - HONEYWELL (Pneu. Only)
 - J - JOHNSON (Pneu. Only)
 - P - POWERS (Pneu. Only)
 - R - ROBERTSHAW (Pneu. Only)
 - D - DDC ACTUATOR (DO Option Only)
 - N - NOT APPLICABLE (NS Option Only)

- FILTER**
- F - Type I Filter (Re-Usable Type)
 - G - Type II Filter (Throw Away Type)

- CONTROLS, DAMPER AND COIL ARRANGEMENTS**
- *1 - Normally Open - Right Hand Controls and Coil Control Panel (Electronic/DO, NS, NA) (All Pneumatic Control Types for Reverse Acting Thermostat)
 - *2 - Normally Open - Left Hand Controls and Coil Control Panel (Electronic/DO, NS, NA) (All Pneumatic Control Types for Reverse Acting Thermostat)
 - 3 - Normally Closed - Right Hand Controls and Coil Control Panel (All Pneumatic Control Types for Direct Acting Thermostat)
 - 4 - Normally Closed - Left Hand Controls and Coil Control Panel (All Pneumatic Control Types for Direct Acting Thermostat)
 - 5 - Normally Open - Right Hand Controls and Coil Control Panel (All Pneumatic Control Types for Direct Acting Thermostat)
 - 6 - Normally Open - Left Hand Controls and Coil Control Panel (All Pneumatic Control Types for Direct Acting Thermostat)
 - 7 - Normally Closed - Right Hand Controls and Coil Control Panel (All Pneumatic Control Types for Reverse Acting Thermostat)
 - 8 - Normally Closed - Left Hand Controls and Coil Control Panel (All Pneumatic Control Types for Reverse Acting Thermostat)

"Electronic and DDC Units DO NOT Fail Open. "1" or "2" is used for Model Numbering Only. Electronic Units are shipped with the Damper in Closed Position. (Refer to the Controls Catalog AV-02 for additional operating information.)"

- LEFT HAND PRIMARY AIR UNIT SHOWN. RIGHT HAND AVAILABLE.
- PRIMARY AIR AND COIL CONTROL PANEL MUST BE ON SAME SIDE OF UNIT.
- ELECTRIC COIL SHOWN ATTACHED, COIL SHIPPED SEPARATE FROM TERMINAL UNIT AS STANDARD.

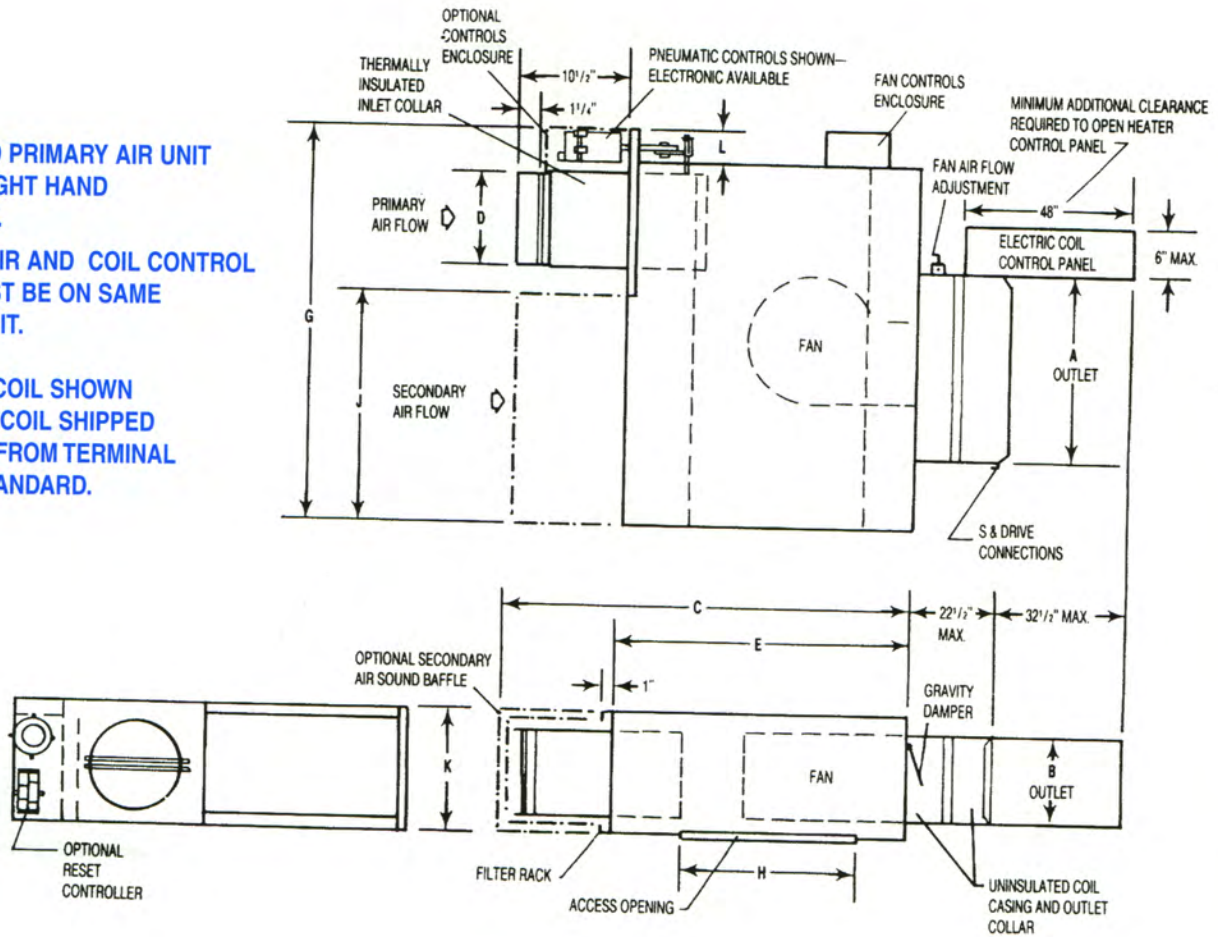

DIMENSIONS LISTED IN INCHES

Size	*Primary Unit CFM	Nominal Fan CFM @ .10" E.S.P.	Fan H. P.	S & Drive Outlet		C	Inlet D	E	G	H	Secondary Air Inlet		L
				A	B						J	K	
L1	565	565	1/6	14	10	38-1/2	6-7/8	28	31-1/2	18	13	11	3-1/2
L2	875	875	1/4	14	10	38-1/2	7-7/8	28	31-1/2	18	13	11	3-1/2
L3	1300	1300	(2) 1/6	20	10	47	9-7/8	33	48-1/2	18	31	11	3-1/2
L4	1940	1940	(2) 1/4	20	10	47	9 x 12	33	48-1/2	18	28	11	3-1/2

*Refer to "Primary Air Inlet Parameters" (page 6) when selecting MINIMUM and MAXIMUM CFM.