

FAN TERMINAL UNITS – Constant Volume (Series Flow), Quiet Design

Models ACFQ w/o Coil
ACWQ w/Hot Water Coil
ACEQ w/Electric Coil

The **Carnes** quiet constant volume fan terminals are designed for noise sensitive applications such as offices, theaters, schools and libraries. The constant volume fan runs continuously in the occupied mode, providing constant background sound to the space.

The primary air damper operates in the same manner as a standard throttling unit, except that all of the primary air is sent through the in-line (series) fan.

Integral sound baffles and isolated motor mounting ensure low sound levels throughout the airflow range.

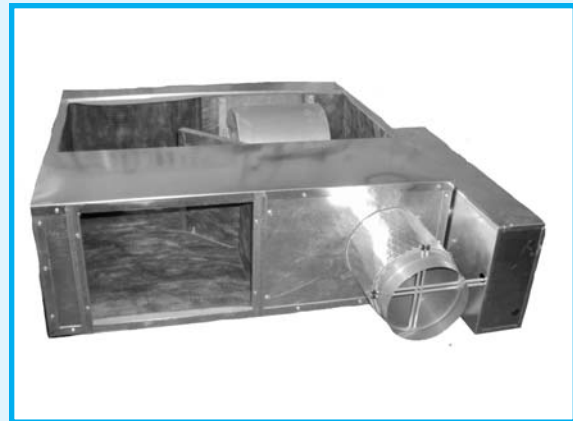

Features Include:

- Airflow capacities to 2450 CFM.
- Durable 20 gauge galvanized steel casing construction.
- Bottom access panel for internal components.
- Flange or slip and drive discharge connections.
- Forward curved centrifugal type fan assemblies with thermally protected, permanent split capacitor type 120 or 277 volt, single phase, fractional horsepower motors.
- Adjustable SCR fan speed control.
- Fan/motor assemblies are isolated from the casing using rubber isolators to minimize vibration transmission.
- Low leakage primary air damper design.
- Secondary air filter rack.
- Performance data based on tests conducted in accordance with ARI Standard 880-98.
- Air flow switch.
- All units are equipped with pressure independent pneumatic or electronic controls.
- Field adjustable P/E switch with pneumatic controls.
- Averaging type velocity sensor and calibration chart for measuring air flow through the primary air damper.
- Insulation is 1" thick, 1-1/2 lb. dual density fiberglass with surface treated to prevent air erosion, UL listed and meets NFPA 90A requirements.
- Damper controls and fan controls are located in one enclosure.
- ARI listed.
- Optional ETL listing.
- Optional one or two row hot water coils (Model ACW). Coil is factory attached to the unit discharge.
- Optional one, two or three stage electric reheat coils (Model ACE). Coil is factory attached to unit discharge or shipped separately for field mounting.
- Optional secondary air filters, Class I (re-usable) or Class II (throw away).
- Optional non-fused or fused fan disconnect switch.
- Optional foil coated insulation (Hospital, Laboratory, etc. applications).

Available Modules:

- Basic control unit — **Model ACFQ.**
- Basic control unit with hot water coil — **Model ACWQ.**
- Basic control unit with electric coil — **Model ACEQ.**



Foil Faced Insulation
Available

FAN CURVES CFM vs EXTERNAL STATIC PRESSURE

FAN POWERED UNITS

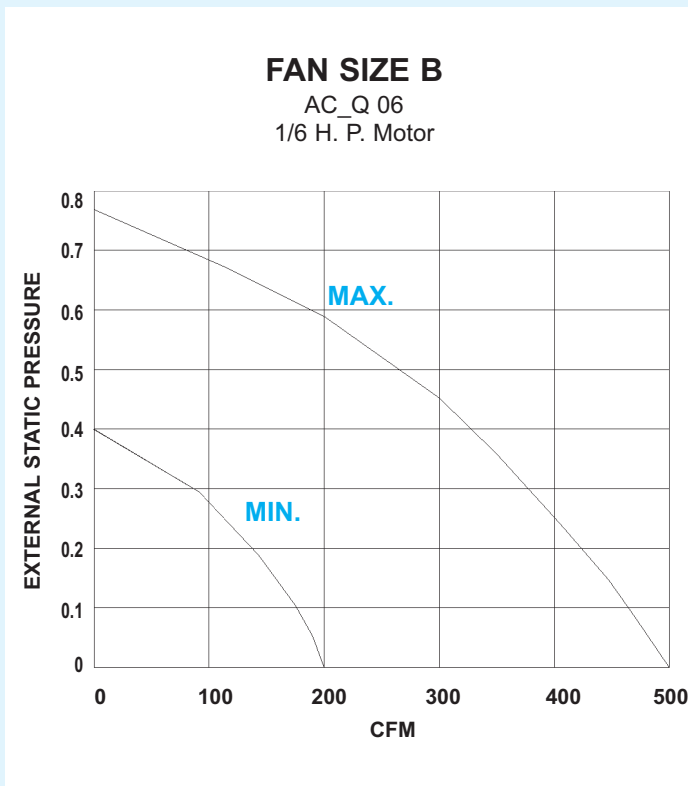
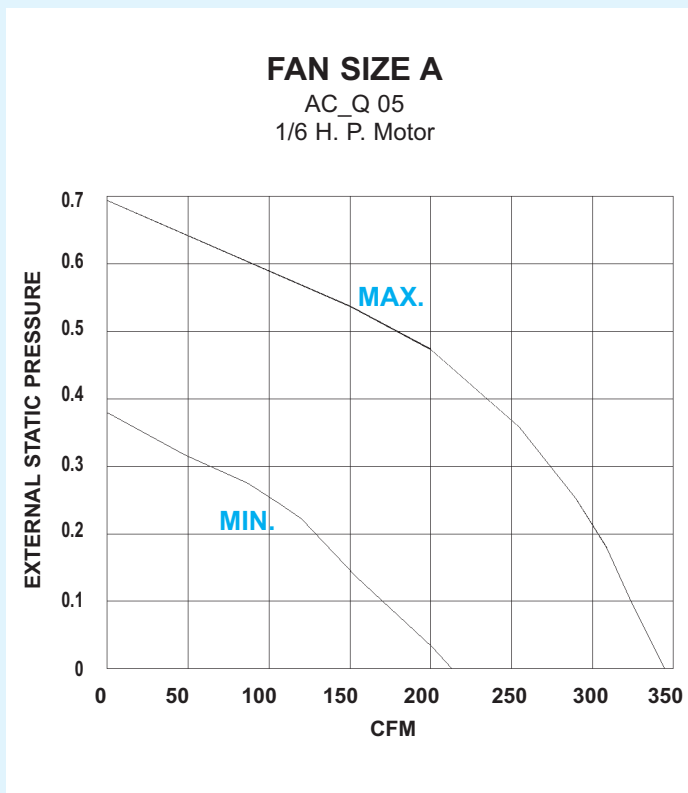

- NOTES:**
1. External static pressure (ESP) consists of down stream ductwork, coils, flex duct, etc.
 2. Pressure drops due to heating coils are treated as external static pressure .
 3. For proper operation, the downstream ESP must be at least 0.20" W. G.

FAN CURVES CFM vs EXTERNAL STATIC PRESSURE

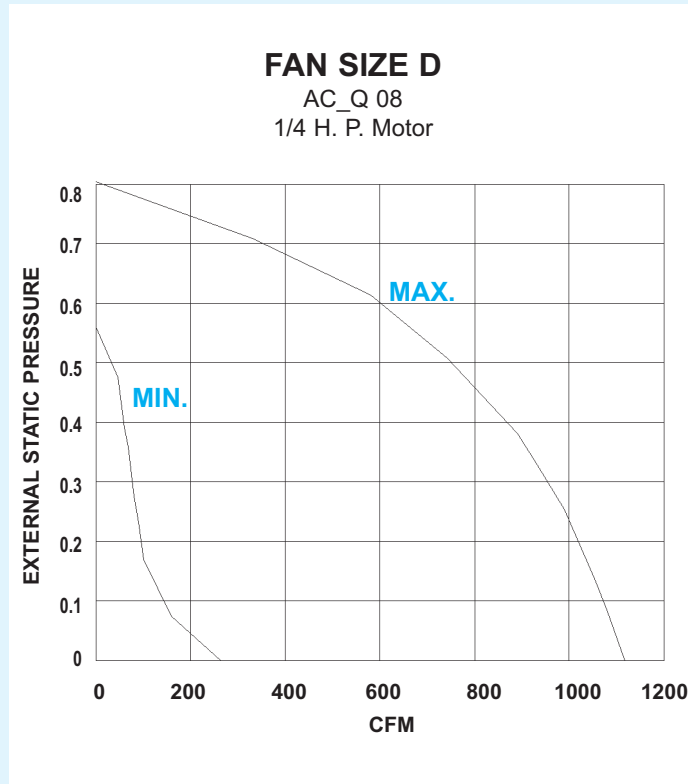
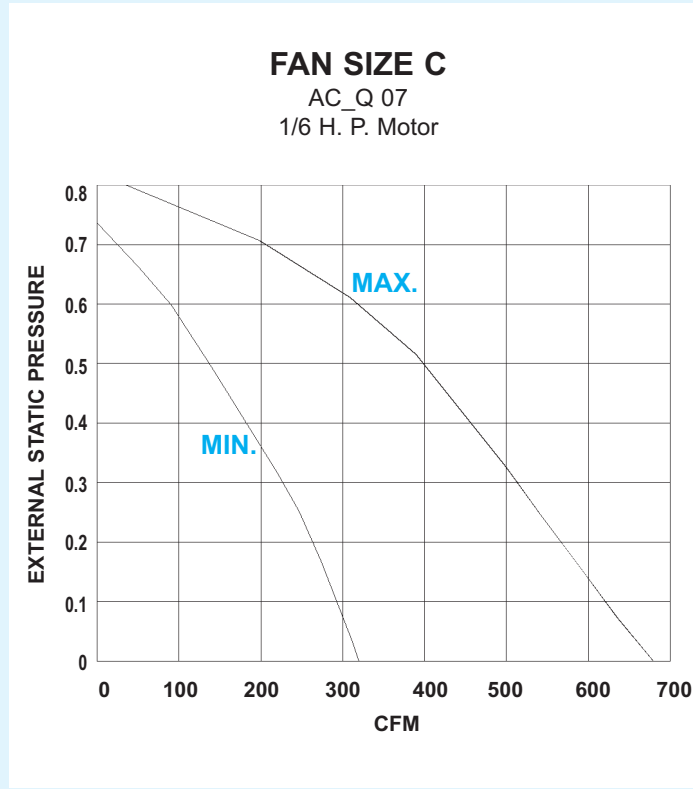

FAN POWERED UNITS

- NOTES:** 1. External static pressure (ESP) consists of down stream ductwork, coils, flex duct, etc.
2. Pressure drops due to heating coils are treated as external static pressure .
3. For proper operation, the downstream ESP must be at least 0.20" W. G.

FAN CURVES CFM vs EXTERNAL STATIC PRESSURE

FAN POWERED UNITS

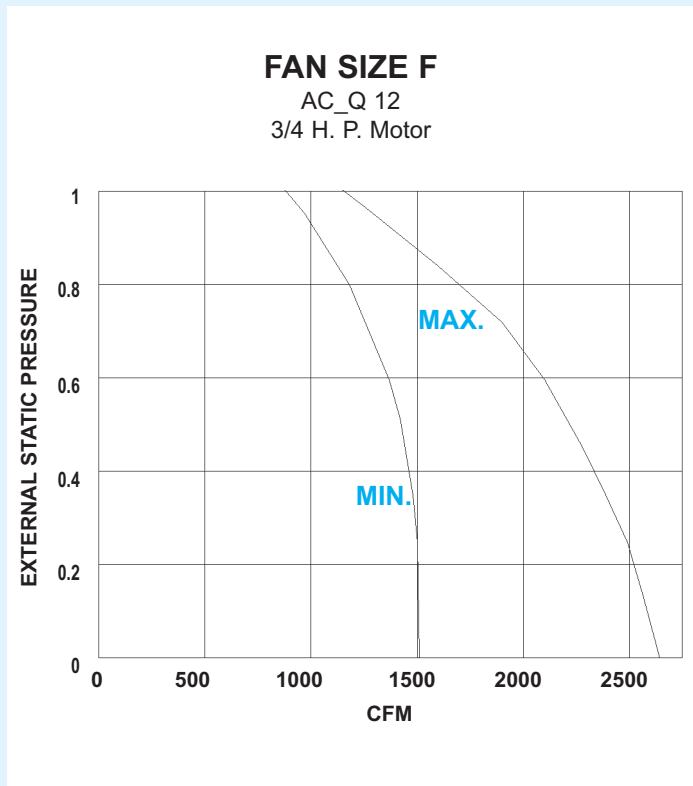
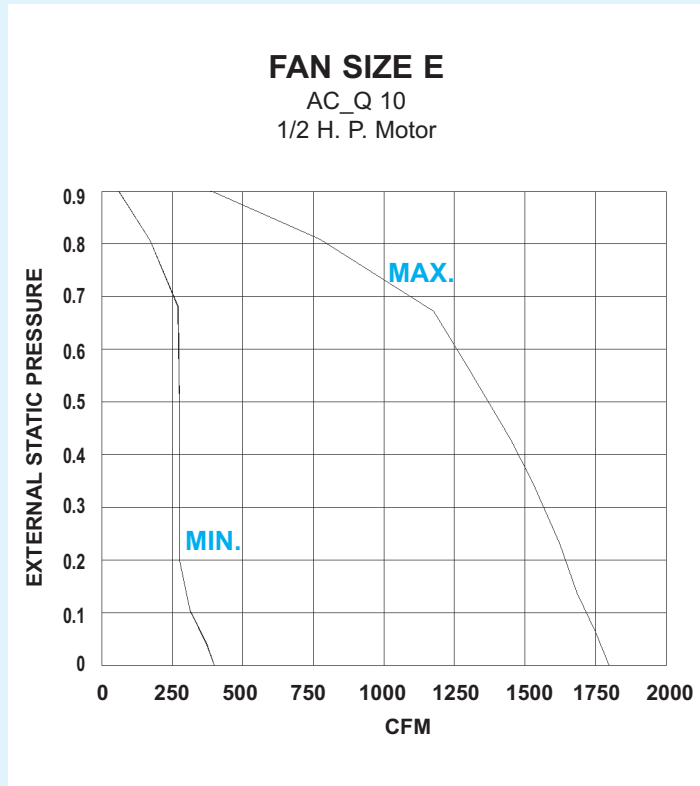

- NOTES:** 1. External static pressure (ESP) consists of down stream ductwork, coils, flex duct, etc.
2. Pressure drops due to heating coils are treated as external static pressure .
3. For proper operation, the downstream ESP must be at least 0.20" W. G.

PERFORMANCE DATA – Constant Volume (Series Flow), Quiet Design

Model AC _ Q 05A

(FAN ON — 100% Primary Air/Mixing/100% Secondary Air)

Primary/ Secondary CFM	Primary Air ΔP_s	Discharge Sound							Radiated Sound								
		Sound Power db							Max. NC	Sound Power db							Max. NC
		Octave Band								Octave Band							
2	3	4	5	6	7	NC	2	3	4	5	6	7	NC				
290/0	-0.040	63	57	51	56	53	48	11	59	54	47	41	34	29	17		
	0.5	64	57	52	55	52	48	11	61	54	47	41	34	31	18		
	1	65	57	52	55	52	49	11	63	55	47	42	37	36	20		
	3	65	58	52	55	52	49	12	63	57	49	45	46	46	21		
145/145	0.5	60	54	50	53	50	46	--	55	50	46	39	32	29	14		
	1	62	55	51	54	51	48	10	58	53	46	41	35	34	16		
	3	62	56	52	54	51	48	10	58	54	47	44	45	44	17		
0/290	—	62	56	51	55	52	48	10	56	51	47	40	35	31	15		
200/0	-0.153	57	51	47	49	45	40	--	54	49	43	37	28	25	11		
	0.5	58	51	47	49	45	40	--	56	49	43	37	29	26	11		
	1	58	51	47	48	36	40	--	57	50	43	38	34	32	13		
	3	59	53	49	48	45	42	--	58	52	45	42	45	44	17		
100/100	0.5	54	50	47	47	43	38	--	52	48	42	36	26	25	10		
	1	56	51	46	47	44	40	--	53	49	42	36	32	31	11		
	3	56	51	46	47	44	40	--	53	49	43	41	45	44	17		
0/200	—	57	51	48	48	44	40	--	51	47	42	36	25	25	10		
100/0	0	52	47	40	42	37	30	--	52	48	42	35	24	23	10		
	0.5	52	47	40	42	37	30	--	52	48	42	36	26	25	10		
	1	52	47	40	42	37	30	--	52	48	42	36	32	29	10		
	3	52	47	40	42	37	35	--	53	48	43	41	44	44	17		
50/50	0.5	51	45	38	39	34	27	--	52	48	42	35	25	23	10		
	1	51	46	39	41	36	30	--	52	48	43	36	32	31	11		
	3	52	46	41	42	37	34	--	52	48	43	40	44	44	17		
0/100	—	52	47	41	42	37	31	--	52	48	42	35	24	23	10		

FAN POWERED UNITS

- NOTES:**
1. ΔP_s static pressure difference from inlet to discharge.
 2. The lowest value of ΔP_s is the minimum pressure required to deliver CFM shown with primary damper in wide open position.
 3. ΔP_s does not include hot water or electric coils.
 4. (--) indicates NC levels less than 10.

NC Levels are derived from tests conducted in accordance with ARI Standard 880-98 and are calculated in accordance with ARI Standard 885-98 as application data based on the following:

Discharge NC levels are based on —

- a) 5 foot rectangular 12" x 12" duct lined with 1" fiberglass insulation.
- b) 6 foot lined flex duct (8" diameter).
- c) Maximum of 300 CFM per outlet.
- d) Space effect factor (5000ft³) at 10 feet from outlet.
- e) End reflection.
- f) Environmental adjustment factor.

Radiated NC levels are based on —

- a) Plenum/ceiling effect - 5/8" mineral fiber tile, 35 lb/ft³ - 3 foot plenum
- b) Space effect factor (5000ft³) at 10 feet from source.
- c) Environmental adjustment factor.



A Participating Member
in the ARI 880
Certification Program

PERFORMANCE DATA – Constant Volume (Series Flow), Quiet Design

Model AC _ Q 06B

(FAN ON — 100% Primary Air/Mixing/100% Secondary Air)

FAN POWERED UNITS

Primary/ Secondary CFM	Primary Air ΔP_s	Discharge Sound							Radiated Sound								
		Sound Power db							Max. NC	Sound Power db							Max. NC
		Octave Band								Octave Band							
		2	3	4	5	6	7		2	3	4	5	6	7			
400/0	-0.069	70	61	57	61	59	56	15	63	56	52	46	39	37	21		
	0.5	70	62	58	62	59	57	16	64	57	52	47	39	37	22		
	1	70	63	58	62	59	57	16	65	58	53	47	41	39	23		
	3	71	64	59	62	60	58	17	65	60	54	49	46	45	24		
200/200	0.5	69	61	58	61	58	56	15	61	55	52	46	39	37	21		
	1	69	61	58	61	58	56	15	63	56	52	46	40	38	21		
	3	69	62	58	62	59	56	15	63	57	53	48	45	44	22		
0/200	—	69	62	59	63	59	57	16	63	57	53	47	39	37	22		
250/0	-0.185	61	54	49	53	49	44	--	56	50	46	39	31	27	14		
	0.5	61	54	49	53	49	46	--	56	50	46	39	32	28	14		
	1	62	55	50	53	49	46	--	56	50	46	40	35	33	14		
	3	62	55	50	53	49	46	--	57	52	49	44	45	43	18		
125/125	0.5	62	54	50	53	49	46	--	54	49	46	39	32	28	14		
	1	62	55	50	53	49	46	--	54	49	46	39	33	31	14		
	3	62	55	51	54	50	47	--	55	50	47	42	44	43	16		
0/250	—	61	54	50	53	49	46	--	53	49	46	39	31	27	14		
120/0	-0.224	53	47	41	43	37	31	--	52	47	42	33	24	21	10		
	0.5	52	47	41	43	37	31	--	52	47	44	36	28	24	12		
	1	52	47	41	43	37	33	--	52	47	44	36	32	30	12		
	3	53	48	43	44	39	36	--	52	47	44	41	44	43	16		
60/60	0.5	55	48	43	44	39	35	--	53	49	44	36	28	24	12		
	1	53	47	43	44	39	35	--	53	49	44	36	32	30	12		
	3	53	47	42	43	37	24	--	54	49	45	41	44	45	18		
0/120	—	53	48	42	44	39	35	--	54	49	44	36	28	24	12		

- NOTES:**
1. ΔP_s static pressure difference from inlet to discharge.
 2. The lowest value of ΔP_s is the minimum pressure required to deliver CFM shown with primary damper in wide open position.
 3. ΔP_s does not include hot water or electric coils.
 4. (--) indicates NC levels less than 10.

NC Levels are derived from tests conducted in accordance with ARI Standard 880-98 and are calculated in accordance with ARI Standard 885-98 as application data based on the following:

Discharge NC levels are based on —

- a) 5 foot rectangular 12" x 12" duct lined with 1" fiberglass insulation.
- b) 6 foot lined flex duct (8" diameter).
- c) Maximum of 300 CFM per outlet.
- d) Space effect factor (5000ft³) at 10 feet from outlet.
- e) End reflection.
- f) Environmental adjustment factor.

Radiated NC levels are based on —

- a) Plenum/ceiling effect - 5/8" mineral fiber tile, 35 lb/ft³ - 3 foot plenum
- b) Space effect factor (5000ft³) at 10 feet from source.
- c) Environmental adjustment factor.



A Participating Member
in the ARI 880
Certification Program

PERFORMANCE DATA – Constant Volume (Series Flow), Quiet Design

Model AC _ Q 07C

(FAN ON — 100% Primary Air/Mixing/100% Secondary Air)

Primary/ Secondary CFM	Primary Air ΔP_s	Discharge Sound							Radiated Sound								
		Sound Power db							Max. NC	Sound Power db							Max. NC
		Octave Band								Octave Band							
2	3	4	5	6	7	2	3	4	5	6	7						
530/0	-0.132	75	67	62	67	65	62	21	70	63	56	51	44	41	30		
	0.5	75	67	62	67	64	62	21	70	63	56	51	44	41	30		
	1	75	67	62	68	65	63	22	70	63	56	51	45	43	30		
	3	76	68	62	68	65	63	22	71	64	57	52	48	46	31		
265/265	0.5	76	67	62	68	65	62	22	69	63	55	52	44	42	28		
	1	76	67	62	68	65	62	22	69	63	56	52	44	42	28		
	3	76	67	62	68	65	62	22	69	63	56	52	48	46	28		
0/530	—	75	67	62	68	64	62	21	69	64	56	52	44	41	29		
400/0	-0.188	67	61	57	60	57	54	13	63	57	51	46	38	35	21		
	0.5	70	62	59	62	59	56	15	64	58	51	46	39	36	22		
	1	70	62	59	63	59	57	16	66	60	52	47	40	38	24		
	3	71	64	59	63	60	58	17	67	61	54	49	46	45	26		
200/200	0.5	69	63	58	62	59	56	15	63	57	51	46	39	38	21		
	1	71	63	58	62	59	57	16	64	57	51	47	40	38	22		
	3	71	64	58	62	59	57	16	64	58	52	48	46	44	22		
0/400	—	70	63	59	62	59	56	15	65	59	52	47	40	38	23		
250/0	-0.267	58	52	47	50	45	41	--	53	49	44	38	31	27	12		
	0.5	58	52	47	50	46	42	--	54	50	45	38	31	28	13		
	1	58	52	48	51	46	43	--	55	51	46	39	34	31	14		
	3	59	54	49	52	46	43	--	57	53	48	44	45	43	17		
125/125	0.5	57	51	46	49	45	40	--	54	50	45	37	31	28	13		
	1	57	52	47	50	45	40	--	54	50	45	38	33	31	13		
	3	58	52	47	51	46	42	--	54	51	46	42	44	43	16		
0/250	—	59	54	48	50	46	42	--	54	50	44	37	29	27	12		

- NOTES:**
1. ΔP_s static pressure difference from inlet to discharge.
 2. The lowest value of ΔP_s is the minimum pressure required to deliver CFM shown with primary damper in wide open position.
 3. ΔP_s does not include hot water or electric coils.
 4. (--) indicates NC levels less than 10.

NC Levels are derived from tests conducted in accordance with ARI Standard 880-98 and are calculated in accordance with ARI Standard 885-98 as application data based on the following:

Discharge NC levels are based on —

- a) 5 foot rectangular 12" x 12" duct lined with 1" fiberglass insulation.
- b) 6 foot lined flex duct (8" diameter).
- c) Maximum of 300 CFM per outlet.
- d) Space effect factor (5000ft³) at 10 feet from outlet.
- e) End reflection.
- f) Environmental adjustment factor.

Radiated NC levels are based on —

- a) Plenum/ceiling effect - 5/8" mineral fiber tile, 35 lb/ft³ - 3 foot plenum
- b) Space effect factor (5000ft³) at 10 feet from source.
- c) Environmental adjustment factor.



ARI Standard 880
A Participating Member
in the ARI 880
Certification Program

FAN POWERED UNITS

PERFORMANCE DATA – Constant Volume (Series Flow), Quiet Design

Model AC _ Q 08D

(FAN ON — 100% Primary Air/Mixing/100% Secondary Air)

FAN POWERED UNITS

Primary/ Secondary CFM	Primary Air ΔP_s	Discharge Sound							Radiated Sound								
		Sound Power db							Max. NC	Sound Power db							Max. NC
		Octave Band								Octave Band							
2	3	4	5	6	7	NC	2	3	4	5	6	7	NC				
1000/0	-0.140	73	70	69	71	67	65	22	68	65	59	54	46	45	31		
	0.5	76	71	67	70	66	64	22	71	67	59	53	46	45	33		
	1	76	71	67	70	65	64	22	71	67	59	53	46	45	33		
	3	77	72	67	70	66	64	23	72	68	61	55	49	48	34		
500/500	0.5	73	68	66	69	64	63	20	67	65	58	53	44	44	30		
	1	73	68	66	69	64	63	20	68	65	58	54	45	45	30		
	3	73	68	66	69	65	63	20	69	66	59	54	48	47	31		
0/1000	—	72	66	65	69	64	62	19	68	65	58	54	45	44	30		
750/0	-0.156	67	62	60	61	58	56	13	63	60	53	45	38	37	24		
	0.5	71	65	63	65	61	59	16	65	62	55	49	41	40	27		
	1	71	65	63	65	61	59	16	66	63	56	50	42	41	28		
	3	72	67	64	66	62	60	17	67	65	58	53	47	46	30		
375/375	0.5	69	63	62	63	59	57	14	64	61	54	48	39	39	25		
	1	69	63	62	64	60	58	15	65	61	55	48	41	40	25		
	3	70	64	63	64	60	58	15	65	62	56	52	46	45	27		
0/750	—	69	62	62	63	58	56	13	62	61	53	47	39	39	25		
500/0	-0.216	60	53	51	52	48	44	--	57	54	46	39	31	28	17		
	0.5	64	58	56	56	52	50	--	60	56	49	42	34	33	19		
	1	64	58	56	56	52	50	--	61	57	50	43	37	35	21		
	3	65	59	57	57	53	51	--	62	60	55	49	46	44	24		
250/250	0.5	62	56	55	55	51	48	--	57	55	48	41	33	31	18		
	1	63	56	55	55	51	48	--	57	55	48	42	35	33	18		
	3	63	57	55	55	52	49	--	59	56	51	47	45	43	20		
0/500	—	63	56	55	55	51	48	--	58	54	48	39	31	30	17		

- NOTES:**
1. ΔP_s static pressure difference from inlet to discharge.
 2. The lowest value of ΔP_s is the minimum pressure required to deliver CFM shown with primary damper in wide open position.
 3. ΔP_s does not include hot water or electric coils.
 4. (--) indicates NC levels less than 10.

NC Levels are derived from tests conducted in accordance with ARI Standard 880-98 and are calculated in accordance with ARI Standard 885-98 as application data based on the following:

Discharge NC levels are based on —

- a) 5 foot rectangular 12" x 12" duct lined with 1" fiberglass insulation.
- b) 6 foot lined flex duct (8" diameter).
- c) Maximum of 300 CFM per outlet.
- d) Space effect factor (5000ft³) at 10 feet from outlet.
- e) End reflection.
- f) Environmental adjustment factor.

Radiated NC levels are based on —

- a) Plenum/ceiling effect - 5/8" mineral fiber tile, 35 lb/ft³ - 3 foot plenum
- b) Space effect factor (5000ft³) at 10 feet from source.
- c) Environmental adjustment factor.



A Participating Member
in the ARI 880
Certification Program

PERFORMANCE DATA – Constant Volume (Series Flow), Quiet Design

Model AC _ Q 10E

(FAN ON — 100% Primary Air/Mixing/100% Secondary Air)

Primary/ Secondary CFM	Primary Air ΔP_s	Discharge Sound							Radiated Sound								
		Sound Power db							Max. NC	Sound Power db							Max. NC
		Octave Band								Octave Band							
2	3	4	5	6	7	2	3	4	5	6	7						
1600/0	-0.012	77	75	72	75	71	69	25	71	66	59	53	48	47	31		
	0.5	77	74	69	71	67	66	24	72	66	59	53	48	47	32		
	1	77	73	68	70	67	66	23	73	67	60	54	48	47	33		
	3	78	73	68	69	67	65	23	75	68	62	55	51	49	36		
800/800	0.5	76	73	69	71	67	65	23	71	63	58	52	46	45	31		
	1	76	73	68	70	67	65	23	72	63	58	52	46	45	32		
	3	76	73	68	70	67	65	23	72	67	61	55	49	48	33		
0/1600	—	74	74	71	74	70	70	26	68	63	59	55	48	48	28		
1300/0	-0.075	71	70	67	67	64	63	19	68	60	55	49	44	42	27		
	0.5	73	71	67	68	65	64	21	71	64	57	51	45	44	31		
	1	74	71	67	68	65	63	21	71	65	58	51	46	45	31		
	3	75	72	67	68	65	63	22	72	66	60	53	50	48	32		
650/650	0.5	74	71	66	67	64	63	21	67	62	55	50	44	43	27		
	1	74	71	66	67	64	63	21	68	62	56	50	45	43	27		
	3	74	71	67	68	64	63	21	70	63	59	54	48	47	30		
0/1300	—	68	67	65	65	63	62	18	65	59	54	49	43	42	23		
1000/0	-0.134	64	64	60	60	57	56	12	64	55	51	45	39	38	22		
	0.5	72	69	65	66	62	61	18	67	61	55	49	43	42	26		
	1	72	69	65	66	63	62	18	69	62	55	49	44	43	28		
	3	74	70	65	66	63	61	19	70	65	59	52	48	47	30		
500/500	0.5	70	68	64	65	61	60	17	65	60	53	48	42	41	24		
	1	71	68	64	66	62	61	17	65	60	55	49	43	42	24		
	3	71	68	65	65	62	61	17	67	61	56	53	48	45	26		
0/1000	—	65	62	60	59	57	55	11	63	57	51	45	39	38	21		

FAN POWERED UNITS

- NOTES:**
1. ΔP_s static pressure difference from inlet to discharge.
 2. The lowest value of ΔP_s is the minimum pressure required to deliver CFM shown with primary damper in wide open position.
 3. ΔP_s does not include hot water or electric coils.
 4. (--) indicates NC levels less than 10.

NC Levels are derived from tests conducted in accordance with ARI Standard 880-98 and are calculated in accordance with ARI Standard 885-98 as application data based on the following:

Discharge NC levels are based on —

- a) 5 foot rectangular 12" x 12" duct lined with 1" fiberglass insulation.
- b) 6 foot lined flex duct (8" diameter).
- c) Maximum of 300 CFM per outlet.
- d) Space effect factor (5000ft³) at 10 feet from outlet.
- e) End reflection.
- f) Environmental adjustment factor.

Radiated NC levels are based on —

- a) Plenum/ceiling effect - 5/8" mineral fiber tile, 35 lb/ft³ - 3 foot plenum
- b) Space effect factor (5000ft³) at 10 feet from source.
- c) Environmental adjustment factor.



ARI Standard 880
A Participating Member
in the ARI 880
Certification Program

PERFORMANCE DATA – Constant Volume (Series Flow), Quiet Design

Model AC _ Q 12F

(FAN ON — 100% Primary Air/Mixing/100% Secondary Air)

FAN POWERED UNITS

Primary/ Secondary CFM	Primary Air ΔP_s	Discharge Sound							Radiated Sound								
		Sound Power db							Max. NC	Sound Power db							Max. NC
		Octave Band								Octave Band							
2	3	4	5	6	7	NC	2	3	4	5	6	7	NC				
2450/0	-0.116	77	76	74	77	74	73	27	77	73	65	61	56	54	40		
	0.5	77	76	74	76	74	73	27	79	74	65	60	55	53	41		
	1	79	77	74	76	74	73	27	79	74	65	59	55	52	41		
	3	79	77	74	76	74	73	27	79	75	67	61	57	55	42		
1225/1225	0.5	78	77	74	78	73	73	27	78	74	64	61	55	53	41		
	1	79	77	74	78	74	73	27	78	74	65	61	55	53	41		
	3	79	77	74	76	74	73	27	79	75	66	61	56	54	42		
0/2450	—	76	75	73	77	73	72	26	77	73	64	61	56	53	40		
1950/0	-0.128	68	68	68	67	64	63	17	69	64	58	52	46	44	29		
	0.5	74	72	70	71	68	68	22	75	70	62	57	51	49	36		
	1	75	74	70	72	69	69	23	76	71	62	57	52	50	37		
	3	75	74	70	72	70	69	23	77	72	65	58	54	52	39		
975/975	0.5	72	72	69	71	67	67	21	71	67	59	54	48	46	33		
	1	74	72	70	72	68	68	22	71	67	60	54	49	47	33		
	3	76	73	70	72	69	68	22	71	67	61	57	51	49	33		
0/1950	—	70	68	68	69	65	65	19	70	66	59	53	48	46	31		
1050/0	-0.239	65	62	60	58	54	52	--	61	61	58	45	39	37	27		
	0.5	67	68	64	64	61	60	15	69	64	58	49	44	42	29		
	1	69	69	65	65	62	61	16	70	66	58	50	45	43	31		
	3	70	68	66	66	63	62	16	70	67	62	56	49	48	33		
525/525	0.5	65	65	63	62	58	57	11	66	63	58	48	42	40	28		
	1	65	66	64	63	60	58	12	67	63	58	49	43	41	28		
	3	65	66	64	63	60	58	12	67	63	59	52	47	46	28		
0/1050	—	62	62	63	61	57	55	--	65	61	57	47	41	37	26		

- NOTES:**
1. ΔP_s static pressure difference from inlet to discharge.
 2. The lowest value of ΔP_s is the minimum pressure required to deliver CFM shown with primary damper in wide open position.
 3. ΔP_s does not include hot water or electric coils.
 4. (--) indicates NC levels less than 10.

NC Levels are derived from tests conducted in accordance with ARI Standard 880-98 and are calculated in accordance with ARI Standard 885-98 as application data based on the following:

Discharge NC levels are based on —

- a) 5 foot rectangular 12" x 12" duct lined with 1" fiberglass insulation.
- b) 6 foot lined flex duct (8" diameter).
- c) Maximum of 300 CFM per outlet.
- d) Space effect factor (5000ft³) at 10 feet from outlet.
- e) End reflection.
- f) Environmental adjustment factor.

Radiated NC levels are based on —

- a) Plenum/ceiling effect - 5/8" mineral fiber tile, 35 lb/ft³ - 3 foot plenum
- b) Space effect factor (5000ft³) at 10 feet from source.
- c) Environmental adjustment factor.



A Participating Member
in the ARI 880
Certification Program

MODEL NUMBERING – Constant Volume (Series Flow), Quiet Design

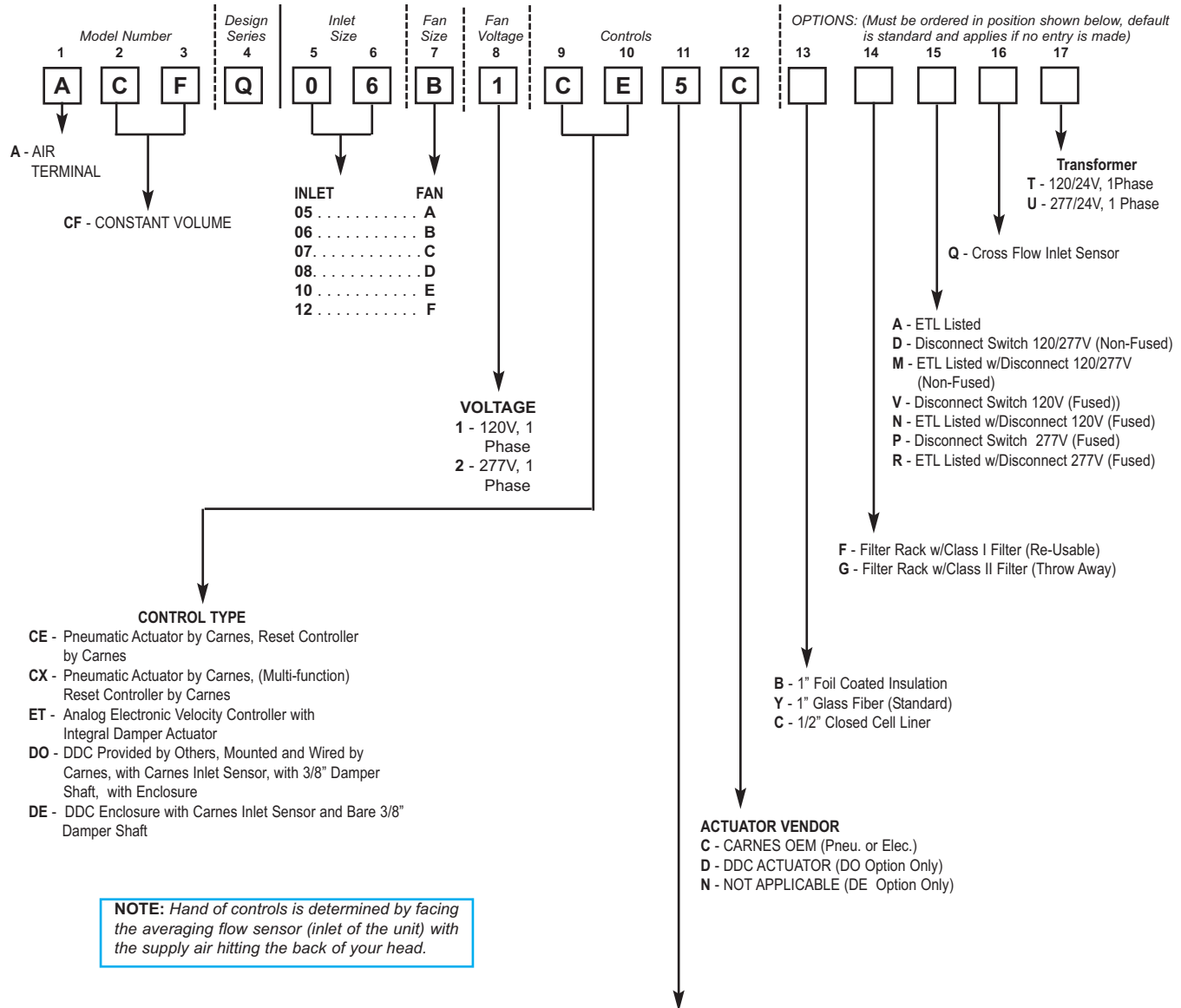

NOTE: Hand of controls is determined by facing the averaging flow sensor (inlet of the unit) with the supply air hitting the back of your head.

Electronic Thermostat

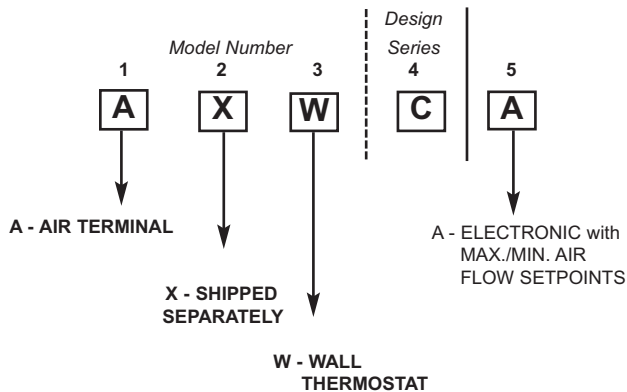

A Carnes Electronic Thermostat **must be ordered** with the Electronic ET Control Option.

CONTROLS AND DAMPER ARRANGEMENT

- *1 - Normally Open - Right Hand Controls
(Electronic/DO, DE, ET)
(All Pneumatic Control Types for Reverse Acting Thermostat)
- *2 - Normally Open - Left Hand Controls
(Electronic/DO, DE, ET)
(All Pneumatic Control Types for Reverse Acting Thermostat)
- 3 - Normally Closed - Right Hand Controls
(All Pneumatic Control Types for Direct Acting Thermostat)
- 4 - Normally Closed - Left Hand Controls
(All Pneumatic Control Types for Direct Acting Thermostat)
- 5 - Normally Open - Right Hand Controls
(All Pneumatic Control Types for Direct Acting Thermostat)
- 6 - Normally Open - Left Hand Controls
(All Pneumatic Control Types for Direct Acting Thermostat)
- 7 - Normally Closed - Right Hand Controls
(All Pneumatic Control Types for Reverse Acting Thermostat)
- 8 - Normally Closed - Left Hand Controls
(All Pneumatic Control Types for Reverse Acting Thermostat)

*Electronic and DDC Units DO NOT Fail Open. "1" or "2" is used for Right or Left Hand Only. Electronic Units are shipped with the Damper in Open Position.

FAN POWERED UNITS

DIMENSIONAL DATA – Constant Volume (Series Flow), Quiet Design

FAN POWERED UNITS

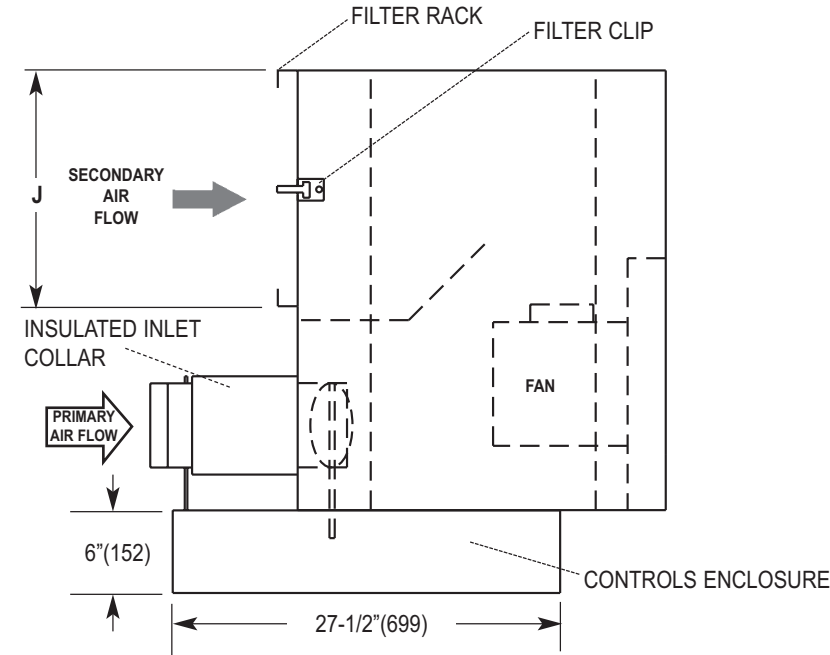

RIGHT HAND PRIMARY AIR UNIT SHOWN. LEFT HAND AVAILABLE

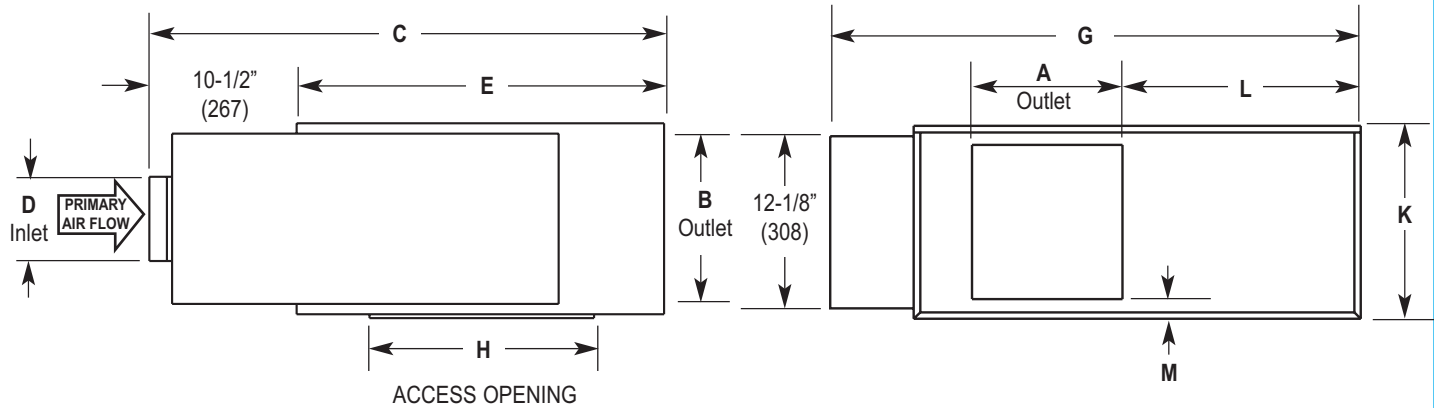

Dimensions Listed in Inches (Millimeters)																
Fan Size	Inlet Size	Primary CFM (L/s)	Secondary CFM (L/s) @ .25" E.S.P.	Fan H.P.	Outlet		C	Inlet		E	G	H	J	K	L	M*
					A	B		D								
A	05	290(137)	290(137)	1/6				4-7/8(124)								
B	06	400(189)	400(189)	1/6	12-3/4 (324)	12 (305)	48-1/4 (1226)	5-7/8(149)	37-3/4 (959)	46 (1168)	20 (508)	17-1/4 (438)	14 (356)	20-3/4 (527)	1 (25)	
C	07	540(255)	540(255)	1/6				6-7/8(175)								
D	08	1000(472)	1000(472)	1/4				7-7/8(200)								
E	10	1500(708)	1600(755)	1/2	16 (406)	15 (381)	54-1/2 (1384)	9-7/8(251)	44 (1117)	54 (1372)	24 (610)	21(533)	17-1/2(445)	27-1/2(699)	1-1/4(32)	
F	12	2300(1085)	2450(1156)	3/4				11-7/8 (302)				21(533)	20-1/8(511)	27-1/2(699)	1-1/4(32)*	

Note: Outlet dimensions refers to the actual opening.
 *For fan size F, left hand units, the "M" dimension is 3-7/8".

MODEL NUMBERING - Constant Volume (Series Flow), Quiet Design

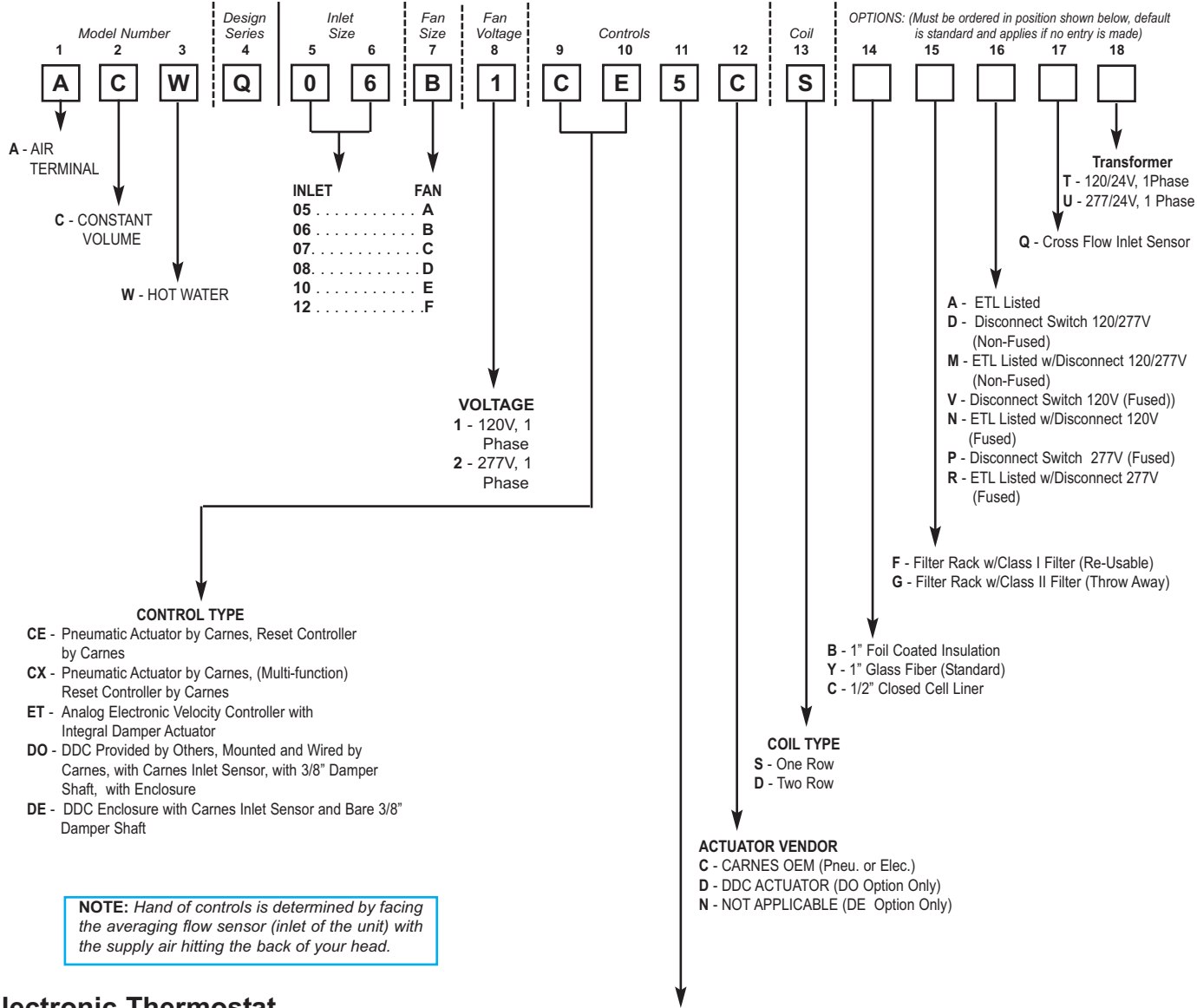

NOTE: Hand of controls is determined by facing the averaging flow sensor (inlet of the unit) with the supply air hitting the back of your head.

Electronic Thermostat

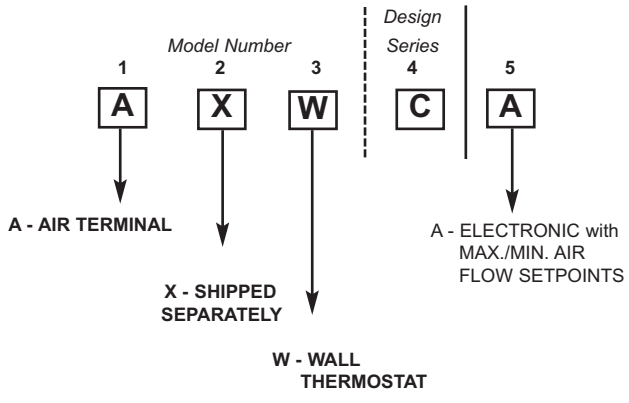

A Carnes Electronic Thermostat **must be ordered** with the Electronic ET Control Option.

- CONTROLS AND DAMPER ARRANGEMENT**
- *1 - Normally Open - Right Hand Controls (Electronic/DO, DE, ET)
(All Pneumatic Control Types for Reverse Acting Thermostat)
 - *2 - Normally Open - Left Hand Controls (Electronic/DO, DE, ET)
(All Pneumatic Control Types for Reverse Acting Thermostat)
 - 3 - Normally Closed - Right Hand Controls (All Pneumatic Control Types for Direct Acting Thermostat)
 - 4 - Normally Closed - Left Hand Controls (All Pneumatic Control Types for Direct Acting Thermostat)
 - 5 - Normally Open - Right Hand Controls (All Pneumatic Control Types for Direct Acting Thermostat)
 - 6 - Normally Open - Left Hand Controls (All Pneumatic Control Types for Direct Acting Thermostat)
 - 7 - Normally Closed - Right Hand Controls (All Pneumatic Control Types for Reverse Acting Thermostat)
 - 8 - Normally Closed - Left Hand Controls (All Pneumatic Control Types for Reverse Acting Thermostat)

*Electronic and DDC Units DO NOT Fail Open. "1" or "2" is used for Right or Left Hand Only. Electronic Units are shipped with the Damper in Open Position.

FAN POWERED UNITS

DIMENSIONAL DATA – Constant Volume (Series Flow), Quiet Design

FAN POWERED UNITS

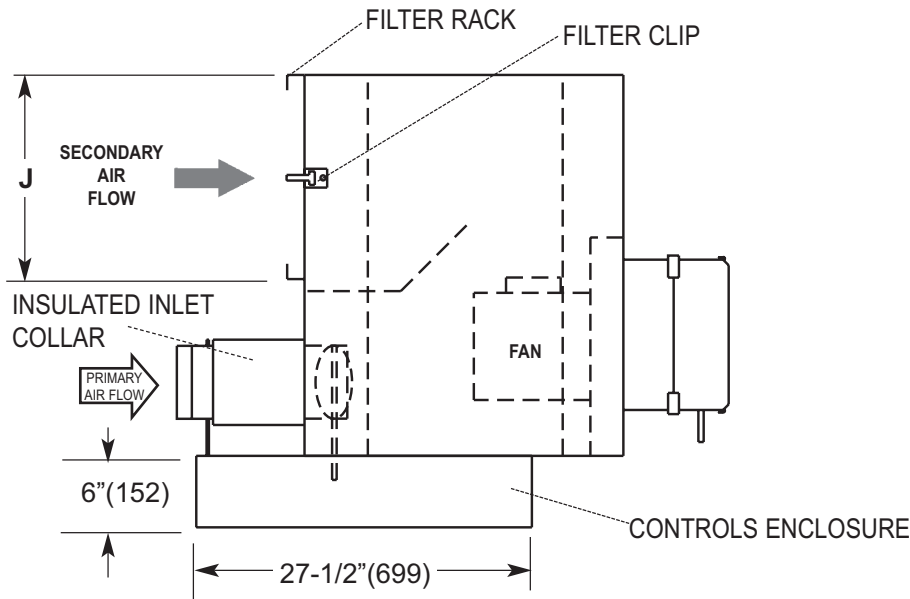

RIGHT HAND PRIMARY AIR UNIT AND COIL SHOWN. LEFT HAND AVAILABLE

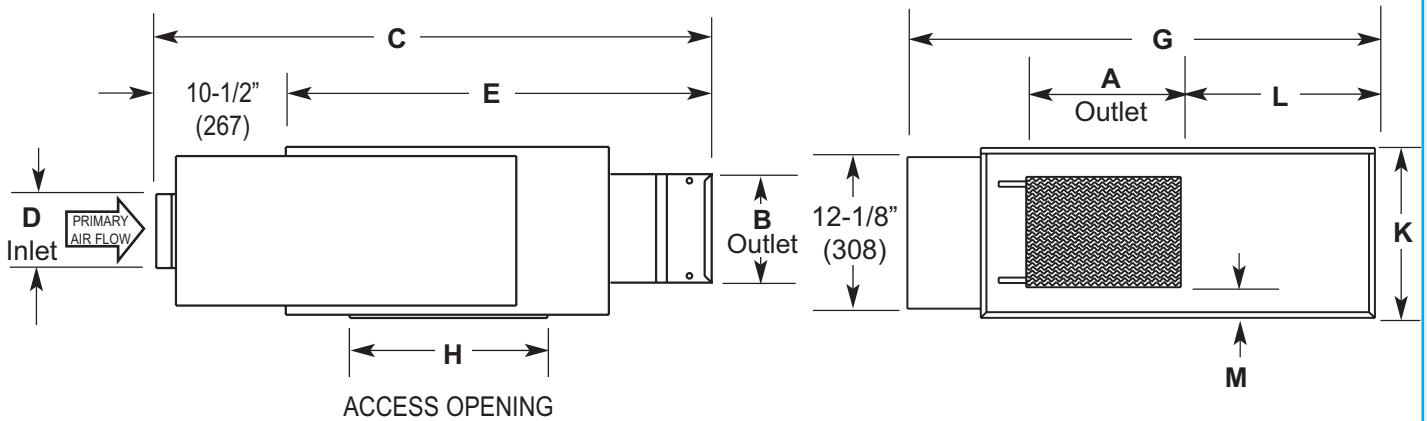

Dimensions Listed in Inches (Millimeters)																		
Fan Size	Inlet Size	Primary CFM (L/s)	Secondary CFM @ .25" E.S.P. (L/s)	Fan H.P.	Outlet				Inlet		1 Row E	2 Row E	G	H	J	K	L	M*
					A	B	1 Row C	2 Row C	D	E								
A	05	290 (137)	290 (137)	1/6					4-7/8 (124)									
B	06	400 (189)	400 (189)	1/6	14 (356)	10 (254)	56-3/8 (1432)	57-3/4 (1467)	5-7/8 (149)	45-7/8 (1165)	47-1/4 (1200)	46 (1168)	20 (508)	17-1/4 (438)	14 (356)	20-3/4 (527)	2 (51)	
C	07	540 (255)	540 (255)	1/6					6-7/8 (175)									
D	08	1000 (472)	1000 (472)	1/4	14 (356)	12-1/2 (318)			7-7/8 (200)								3/4 (19)	
E	10	1500 (708)	1600 (755)	1/2	16 (406)	15 (381)	62-5/8 (1591)	64 (1626)	9-7/8 (251)	52-1/8 (1324)	53-1/2 (1359)	54 (1372)	24 (610)	21 (533)	17-1/2 (445)	27-1/2 (699)	1-1/4 (32)	
F	12	2300 (1085)	2450 (1156)	3/4					11-7/8 (302)					21 (533)	20-1/8 (511)	27-1/2 (699)	1-1/4 (32)*	

Note: Outlet is designed for slip and drive duct connection.

*For fan size "F", left hand units, the "M" dimension is 3-7/8".

MODEL NUMBERING – Constant Volume (Series Flow), Quiet Design

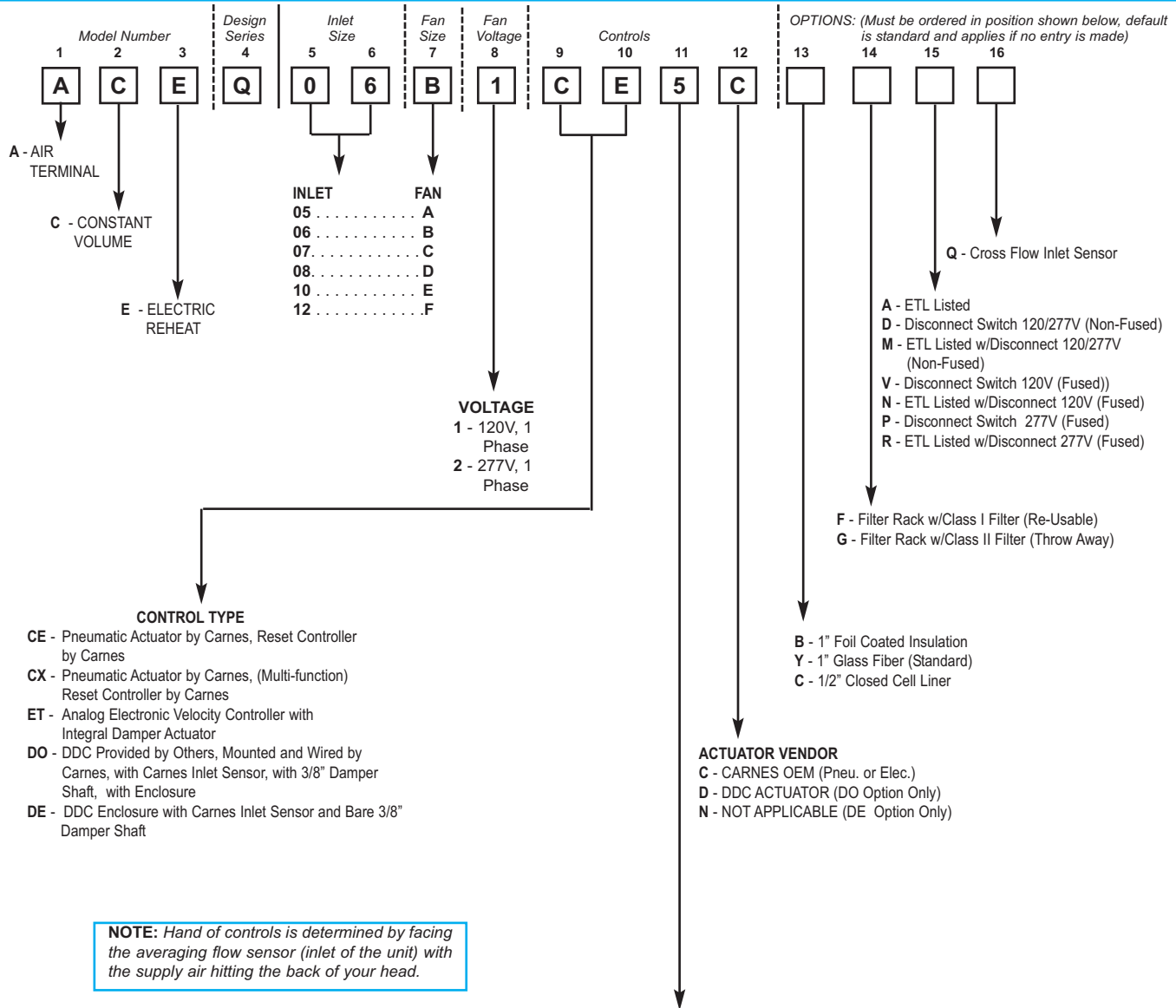

Electronic Thermostat

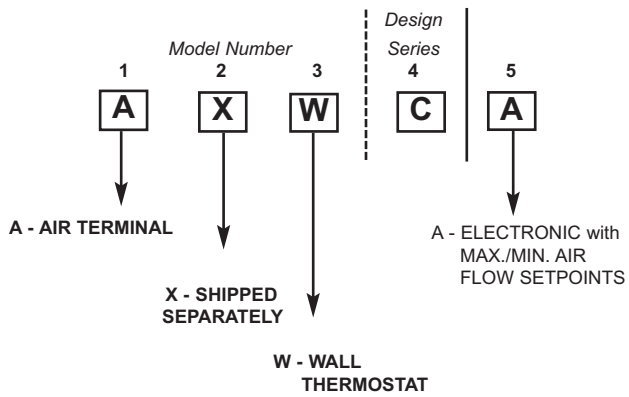

A Carnes Electronic Thermostat **must be ordered** with the Electronic ET Control Option.

*Electronic and DDC Units DO NOT Fail Open. "1" or "2" is used for Right or Left Hand Only. Electronic Units are shipped with the Damper in Open Position.

FAN POWERED UNITS

DIMENSIONAL DATA – Constant Volume (Series Flow), Quiet Design

FAN POWERED UNITS

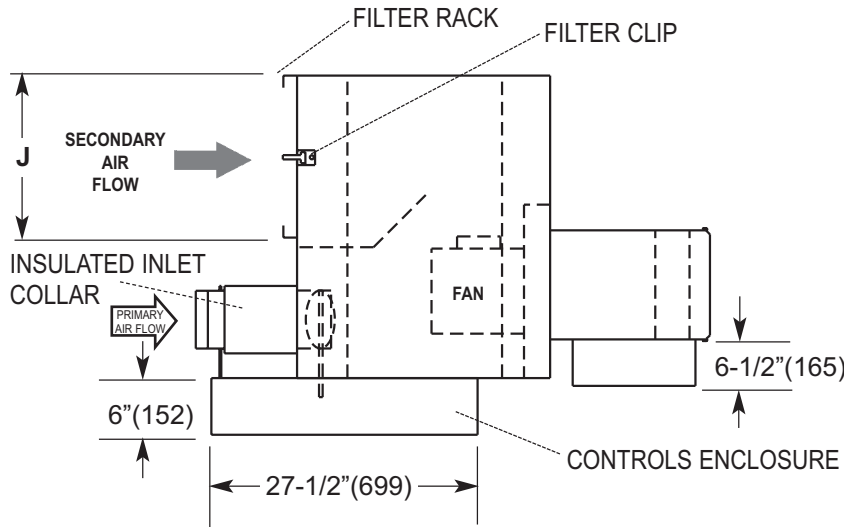

RIGHT HAND PRIMARY AIR UNIT SHOWN. LEFT HAND AVAILABLE

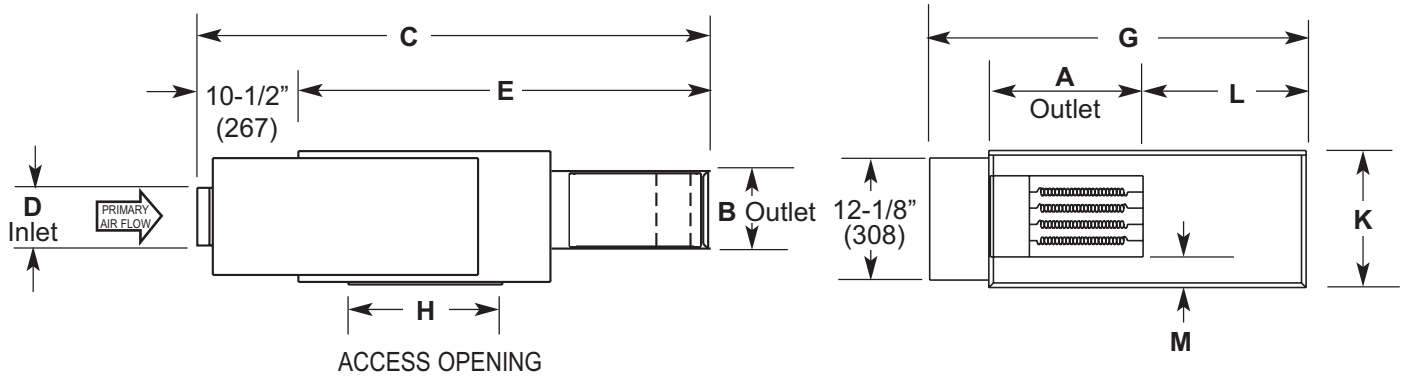

Dimensions Listed in Inches (Millimeters)																
Fan Size	Inlet Size	Primary CFM (L/s)	Secondary CFM (L/s) @ .25" E.S.P.	Fan H.P.	Outlet		C	Inlet		E	G	H	J	K	L	M*
					A	B		D								
A	05	290(137)	290(137)	1/6				4-7/8(124)								
B	06	400(189)	400(189)	1/6	14 (356)	10 (254)	71-1/2 (1816)	5-7/8(149)	61 (1549)	46 (1168)	20 (508)	17-1/4 (438)	14 (356)	20-3/4 (527)	2 (51)	
C	07	540(255)	540(255)	1/6				6-7/8(175)								
D	08	1000(472)	1000(472)	1/4	14(356)	12-1/2(318)	7-7/8(200)	3/4(19)								
E	10	1500(708)	1600(755)	1/2	16 (406)	15 (381)	77-3/4 (1975)	9-7/8(251)	67-1/4 (1708)	54 (1372)	24 (610)	21(533)	17-1/2(445)	27-1/2(699)	1-1/4(32)	
F	12	2300(1085)	2450(1156)	3/4				11-7/8 (302)				21(533)	20-1/8(511)	27-1/2(699)	1-1/4(32)*	

Note: Outlet is designed for slip and drive duct connection.
 *For fan size "F", left hand units, the "M" dimension is 3-7/8".

FAN TERMINAL UNITS – Constant Volume (Series Flow), Underfloor Design

Models **ACF w/o Reheat**
 ACW w/ Hot Water Reheat
 ACE w/ Electric Reheat

The **Carnes** underfloor constant volume fan terminal unit provides constant air volume to the space while retaining the advantages of a variable air volume system.

The primary air control assembly operates in the same manner as a standard throttling control valve when cooling loads are high. As cooling loads diminish the integral blower(s) induces warm ceiling plenum air to maintain constant air volume.

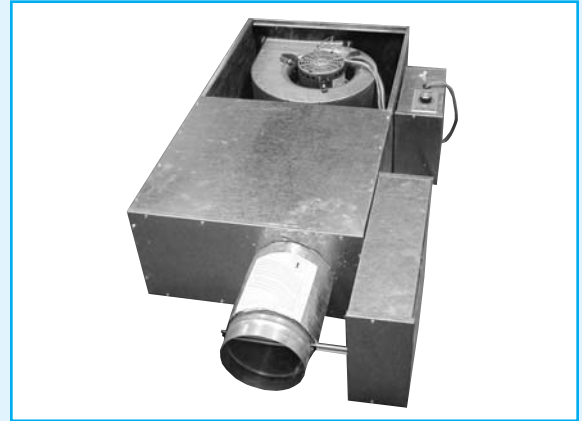

Features Include:

- Air flow capacities to 1525 CFM.
- Durable 22 gauge galvanized steel casing construction.
- Access panel for internal components.
- Standard inlet sizes and flange or slip and drive discharge connections.
- Forward curved centrifugal type fan assemblies with 120 or 277 volt, single phase, fractional horsepower PSC motors.
- Low leakage primary air damper design.
- Secondary air filter rack.
- Performance data based on tests conducted in accordance with ARI Standard 880-98.
- Pressure independent pneumatic or electronic controls available.
- Field adjustable P/E switch with pneumatic controls.
- Averaging type velocity sensor and calibration chart for measuring air flow through the primary air damper.
- Insulation is 1/2" thick, 2.0 lb. dual density fiberglass with surface treated to prevent air erosion, UL listed and meets NFPA 90A requirements.
- Optional primary air controls enclosure.
- Optional one or two row hot water coils (Model ACW). Coil is factory attached to the unit discharge.
- Optional electric reheat coils (Model ACE). Coil is factory attached to unit discharge or shipped separately for field mounting.
- Optional secondary air filters, Class I (re-usable) or Class II (throw away).
- Optional foil coated insulation (Hospital, Laboratory, etc. applications).
- Optional ETL listing.

Available Modules:

- Basic control unit — **Model ACF.**
- Basic control unit with hot water coil — **Model ACW.**
- Basic control unit with electric coil — **Model ACE.**



PERFORMANCE DATA - Constant Volume (Series Flow), Underfloor Design

**UNIT SIZE - U1
Inlet Size - 5"**

(FAN ON — 100% Primary Air/Mix/100% Secondary Air)

FAN POWERED UNITS

Primary/ Secondary CFM	Primary Air ΔP_s	Discharge Sound							Max. NC	Radiated Sound							Max. NC
		Sound Power db Octave Band								Sound Power db Octave Band							
		2	3	4	5	6	7	2		3	4	5	6	7			
290/0	.29	57	54	54	51	45	39	11	58	54	50	45	36	29	19		
	.50	61	55	56	54	47	40	15	60	54	52	49	39	30	21		
	1.00	60	56	58	56	49	41	14	60	56	55	51	42	35	24		
	1.50	62	57	59	57	50	41	17	63	57	57	52	46	40	26		
	3.00	64	59	60	59	51	43	19	63	58	59	51	49	45	28		
150/150	.50	53	50	52	50	43	36	-	54	47	45	43	35	24	14		
	1.00	53	50	52	50	44	37	-	54	48	47	44	39	34	15		
	1.50	53	51	53	51	45	38	-	54	50	48	46	42	40	17		
	3.00	54	52	54	52	46	39	-	55	51	51	49	48	48	23		
0/290	—	51	48	52	50	42	35	-	53	45	44	44	32	21	15		
150/0	.07	47	43	44	40	31	22	-	52	45	41	38	27	20	—		
	.50	51	46	48	43	33	23	-	52	46	43	41	32	24	12		
	1.00	51	47	49	44	34	24	-	52	47	46	43	39	34	14		
	1.50	52	48	50	45	35	24	-	53	48	47	45	42	39	16		
	3.00	53	50	52	48	37	29	-	53	49	50	49	48	48	23		
75/75	.50	45	42	43	39	29	21	-	51	44	41	39	31	24	10		
	1.00	47	43	44	39	30	22	-	51	44	43	41	36	34	12		
	1.50	47	44	45	40	31	22	-	52	45	44	42	40	41	16		
	3.00	48	45	47	42	34	27	-	52	45	45	45	46	48	23		
0/150	—	42	42	45	39	27	21	-	53	45	41	38	27	20	—		
75/0	.02	42	39	40	33	22	20	-	48	39	35	31	19	20	—		
	.50	44	41	41	35	23	20	-	48	41	39	35	29	23	—		
	1.00	44	42	42	37	26	20	-	49	42	41	39	36	34	10		
	1.50	45	43	43	38	27	21	-	49	42	42	40	40	40	15		
	3.00	47	45	46	41	32	24	-	49	43	45	44	46	49	24		
38/38	.50	42	39	40	34	22	20	-	49	41	39	34	28	22	—		
	1.00	42	40	41	35	24	20	-	48	40	39	37	36	36	11		
	1.50	42	41	42	36	26	21	-	49	40	39	38	39	42	17		
	3.00	42	41	42	36	27	24	-	49	41	40	41	43	43	18		
0/75	—	41	40	42	34	22	20	-	48	39	35	31	19	20	—		

- NOTES:**
1. ΔP_s static pressure difference from inlet to discharge.
 2. ΔP_s is the minimum required to deliver CFM shown in the primary damper in open position.
 3. ΔP_s does not include hot water or electric coils.
 4. Dash (- -) indicates NC level less than 10.

NC levels are derived from tests conducted in accordance with ARI Standard 880-98 and are calculated in accordance with Appendix E of ARI Standard 885-98 as application data based on the following:

Discharge NC levels are based on -

- a) 5 foot rectangular duct lined with 1" fiberglass insulation.
- b) 5 foot lined flex duct (8" diameter).
- c) Maximum of 300 CFM per outlet.
- d) Space effect factor (2400 ft³) at 5 feet from outlet.
- e) End reflection.
- f) Environment adjustment factor.

Radiated NC levels are based on -

- a) Plenum/ceiling effect - solid gypsum board.
- b) Environment adjustment factor.



ARI Standard 880
A Participating Member
in the ARI 880
Certification Program

PERFORMANCE DATA - Constant Volume (Series Flow), Underfloor Design

**UNIT SIZE - U2
Inlet Size - 6"**

(FAN ON — 100% Primary Air/Mix/100% Secondary Air)

Primary/ Secondary CFM	Primary Air ΔP_s	Discharge Sound							Radiated Sound								
		Sound Power db Octave Band							Max. NC	Sound Power db Octave Band							Max. NC
		2	3	4	5	6	7	2		3	4	5	6	7			
420/0	.23	59	58	58	56	53	48	15	61	56	53	49	39	29	22		
	.50	60	58	59	59	55	49	15	61	56	55	55	42	32	26		
	1.00	61	58	60	59	55	49	15	61	58	57	56	44	37	27		
	1.50	62	59	60	59	56	49	16	63	59	59	57	47	42	28		
	3.00	64	61	61	60	57	50	18	64	60	60	60	52	49	32		
210/210	.50	57	55	57	56	53	48	12	57	51	50	49	39	29	20		
	1.00	57	55	57	56	53	48	12	57	52	51	50	41	35	21		
	1.50	57	56	57	57	54	49	14	58	53	52	50	44	41	21		
	3.00	58	57	58	57	54	49	15	58	54	56	54	50	49	25		
0/420	—	54	54	56	55	52	47	11	56	49	49	48	38	26	19		
300/0	.12	51	50	51	47	41	35	—	53	48	45	42	30	20	13		
	.50	54	52	55	52	44	36	—	55	50	49	48	35	27	19		
	1.00	55	53	55	52	45	36	10	56	52	52	51	40	35	22		
	1.50	55	54	55	53	45	37	11	57	53	54	52	43	41	23		
	3.00	58	56	58	56	49	39	14	59	56	58	56	50	49	27		
150/150	.50	50	48	50	47	41	33	—	51	46	45	43	32	24	14		
	1.00	50	48	51	48	41	34	—	52	47	47	45	37	35	16		
	1.50	51	49	52	49	42	34	—	53	48	49	46	41	39	18		
	3.00	52	50	53	50	42	34	—	53	50	52	50	48	48	23		
0/300	—	48	46	49	46	40	32	—	52	45	44	43	31	20	14		
200/0	.05	47	46	47	43	36	29	—	51	45	42	40	28	20	11		
	.50	49	48	52	47	38	30	—	51	46	45	45	32	24	16		
	1.00	50	49	53	49	39	31	—	52	48	49	47	38	34	18		
	1.50	51	50	55	49	40	31	—	53	49	51	49	42	40	20		
	3.00	54	53	57	53	43	34	11	54	52	55	53	49	48	24		
100/100	.50	46	45	47	43	35	26	—	51	45	43	41	31	24	12		
	1.00	47	46	47	44	36	27	—	51	45	45	42	36	34	13		
	1.50	48	46	48	44	36	27	—	51	46	46	44	40	40	15		
	3.00	48	48	50	45	38	30	—	52	47	49	48	47	48	23		
0/200	—	46	44	47	42	34	24	—	51	44	44	41	30	20	12		

FAN POWERED UNITS

- NOTES:**
1. ΔP_s static pressure difference from inlet to discharge.
 2. ΔP_s is the minimum required to deliver CFM shown in the primary damper in open position.
 3. ΔP_s does not include hot water or electric coils.
 4. Dash (-) indicates NC level less than 10.

NC levels are derived from tests conducted in accordance with ARI Standard 880-98 and are calculated in accordance with Appendix E of ARI Standard 885-98 as application data based on the following:

Discharge NC levels are based on -

- a) 5 foot rectangular duct lined with 1" fiberglass insulation.
- b) 5 foot lined flex duct (8" diameter).
- c) Maximum of 300 CFM per outlet.
- d) Space effect factor (2400 ft³) at 5 feet from outlet.
- e) End reflection.
- f) Environment adjustment factor.

Radiated NC levels are based on -

- a) Plenum/ceiling effect - solid gypsum board.
- b) Environment adjustment factor.



ARI Standard 880

A Participating Member
in the ARI 880
Certification Program

PERFORMANCE DATA - Constant Volume (Series Flow), Underfloor Design

**UNIT SIZE - U3
Inlet Size - 7"**

(FAN ON — 100% Primary Air/Mix/100% Secondary Air)

FAN POWERED UNITS

Primary/ Secondary CFM	Primary Air ΔP_s	Discharge Sound							Radiated Sound								
		Sound Power db Octave Band							Max. NC	Sound Power db Octave Band							Max. NC
		2	3	4	5	6	7	2		3	4	5	6	7			
680/0	.24	68	67	66	66	64	62	26	70	63	59	58	49	40	30		
	.50	70	69	68	67	66	63	28	70	63	60	59	51	41	31		
	1.00	71	69	68	67	66	63	28	71	64	62	61	52	43	33		
	1.50	71	69	67	67	66	63	28	71	65	63	61	53	45	33		
	3.00	72	70	68	68	67	64	29	74	67	64	64	55	51	36		
340/340	.50	67	65	66	65	64	62	26	68	60	57	56	48	39	27		
	1.00	67	66	66	65	64	62	26	68	60	58	57	49	41	28		
	1.50	67	66	66	65	64	62	26	68	61	59	57	50	43	28		
	3.00	67	66	66	65	64	62	26	68	62	61	60	53	50	32		
0/680	—	66	64	65	65	63	62	26	68	59	55	56	48	39	27		
450/0	.11	57	57	59	57	54	50	14	59	53	52	52	40	28	23		
	.50	59	57	60	59	56	51	15	61	55	53	55	42	32	26		
	1.00	60	58	60	60	56	52	16	62	56	56	56	44	37	27		
	1.50	61	59	61	60	57	52	16	63	57	57	57	46	41	28		
	3.00	63	61	62	61	57	52	18	64	59	61	61	52	50	33		
225/225	.50	58	56	59	57	55	51	14	59	52	51	51	40	31	22		
	1.00	58	57	59	57	55	51	15	59	53	53	51	42	37	22		
	1.50	58	57	59	57	55	51	15	60	53	54	53	44	41	24		
	3.00	59	57	59	58	55	51	15	60	55	56	55	50	48	26		
0/450	—	57	55	57	57	54	50	14	60	51	50	50	40	28	21		
300/0	.05	51	50	52	49	44	38	-	54	47	45	46	33	22	17		
	.50	52	51	54	52	46	39	-	55	50	48	49	36	27	20		
	1.00	54	53	55	53	47	40	10	57	51	51	50	39	36	21		
	1.50	54	53	55	53	47	40	10	57	52	54	53	43	41	24		
	3.00	56	55	57	55	48	41	12	58	55	58	57	50	49	28		
150/150	.50	51	50	52	50	45	38	-	55	47	46	46	34	27	17		
	1.00	52	50	52	50	45	38	-	55	48	48	47	38	35	18		
	1.50	52	50	53	51	45	38	-	55	48	49	48	41	39	19		
	3.00	53	51	53	51	45	38	-	57	50	51	51	48	48	23		
0/300	—	50	50	52	50	45	38	-	56	46	45	47	33	21	18		

- NOTES:**
1. ΔP_s static pressure difference from inlet to discharge.
 2. ΔP_s is the minimum required to deliver CFM shown in the primary damper in open position.
 3. ΔP_s does not include hot water or electric coils.
 4. Dash (-) indicates NC level less than 10.

NC levels are derived from tests conducted in accordance with ARI Standard 880-98 and are calculated in accordance with Appendix E of ARI Standard 885-98 as application data based on the following:

Discharge NC levels are based on -

- a) 5 foot rectangular duct lined with 1" fiberglass insulation.
- b) 5 foot lined flex duct (8" diameter).
- c) Maximum of 300 CFM per outlet.
- d) Space effect factor (2400 ft³) at 5 feet from outlet.
- e) End reflection.
- f) Environment adjustment factor.

Radiated NC levels are based on -

- a) Plenum/ceiling effect - solid gypsum board.
- b) Environment adjustment factor.



ARI Standard 880
A Participating Member
in the ARI 880
Certification Program

PERFORMANCE DATA – Constant Volume (Series Flow), Underfloor Design

**UNIT SIZE - U4
Inlet Size - 8"**

(FAN ON — 100% Primary Air/Mix/100% Secondary Air)

Primary/ Secondary CFM	Primary Air ΔP_s	Discharge Sound							Radiated Sound								
		Sound Power db							Max. NC	Sound Power db							Max. NC
		Octave Band								Octave Band							
2	3	4	5	6	7		2	3	4	5	6	7					
1000/0	.27	75	73	72	71	69	69	32	74	67	63	62	54	45	34		
	.50	77	75	73	72	71	70	34	76	70	65	65	56	47	37		
	1.00	77	76	73	72	71	70	35	76	70	65	65	57	48	37		
	1.50	78	76	73	72	71	70	35	77	71	67	66	57	50	38		
	3.00	79	78	74	73	72	71	37	79	73	69	68	60	55	40		
500/500	.50	77	75	73	72	71	70	35	75	67	62	62	54	46	35		
	1.00	77	75	73	72	71	70	35	75	67	62	62	54	47	35		
	1.50	77	75	73	72	71	70	35	76	67	63	62	55	48	36		
	3.00	77	76	73	73	71	70	36	75	68	65	65	57	53	37		
0/1000	—	75	73	71	71	69	69	32	75	65	61	61	54	46	35		
750/0	.15	68	65	65	65	61	60	24	68	60	58	57	46	36	28		
	.50	70	68	67	66	64	62	26	71	63	59	61	50	40	33		
	1.00	70	68	67	67	64	62	26	71	64	61	61	50	43	33		
	1.50	71	68	67	67	64	62	26	71	65	63	63	52	46	35		
	3.00	72	69	68	67	65	62	27	72	67	66	66	56	53	38		
375/375	.50	69	67	66	66	63	62	26	71	60	57	58	49	40	30		
	1.00	70	67	66	66	63	62	26	71	61	58	58	50	42	30		
	1.50	70	67	66	66	63	62	26	71	62	60	59	51	45	31		
	3.00	70	67	67	66	63	62	26	71	63	62	63	54	51	35		
0/750	—	69	66	66	66	64	63	27	72	60	57	57	51	44	31		
500/0	.07	59	58	59	58	53	50	15	63	54	51	51	39	26	22		
	.50	61	60	61	60	56	52	17	65	56	55	55	43	33	26		
	1.00	63	60	61	60	56	52	17	65	58	56	56	45	39	27		
	1.50	63	61	61	61	56	52	18	65	59	59	58	48	44	30		
	3.00	63	62	62	61	56	52	19	66	62	64	63	53	52	35		
250/250	.50	61	59	59	59	55	53	17	65	54	52	52	41	32	23		
	1.00	62	59	59	59	55	53	17	66	55	54	54	44	38	25		
	1.50	62	59	59	59	55	53	17	66	56	55	55	46	43	26		
	3.00	62	60	60	60	55	53	18	66	58	58	59	51	50	31		
0/500	—	60	59	59	59	55	52	16	69	55	52	53	45	35	27		

- NOTES:**
1. ΔP_s static pressure difference from inlet to discharge.
 2. ΔP_s is the minimum required to deliver CFM shown in the primary damper in open position.
 3. ΔP_s does not include hot water or electric coils.
 4. Dash (- -) indicates NC level less than 10.

NC levels are derived from tests conducted in accordance with ARI Standard 880-98 and are calculated in accordance with Appendix E of ARI Standard 885-98 as application data based on the following:

Discharge NC levels are based on -

- a) 5 foot rectangular duct lined with 1" fiberglass insulation.
- b) 5 foot lined flex duct (8" diameter).
- c) Maximum of 300 CFM per outlet.
- d) Space effect factor (2400 ft³) at 5 feet from outlet.
- e) End reflection.
- f) Environment adjustment factor.

Radiated NC levels are based on -

- a) Plenum/ceiling effect - solid gypsum board.
- b) Environment adjustment factor.



A Participating Member
in the ARI 880
Certification Program

PERFORMANCE DATA - Constant Volume (Series Flow), Underfloor Design

**UNIT SIZE - U5
Inlet Size - 10"**

(FAN ON — 100% Primary Air/Mix/100% Secondary Air)

FAN POWERED UNITS

Primary/ Secondary CFM Ps	Primary Air $\Delta 2$	Discharge Sound							Max. 2	Radiated Sound						Max.
		Sound Power db Octave Band								Sound Power db Octave Band						
		3	4	5	6	7	NC	3		4	5	6	7	NC		
1525/0	.24	82	79	77	77	74	74	38	80	73	66	66	59	50	41	
	.50	84	79	77	77	75	74	39	82	74	67	67	60	51	44	
	1.00	84	81	78	78	76	74	41	82	75	69	69	62	53	44	
	1.50	85	81	79	78	77	75	41	83	77	70	70	62	54	45	
	3.00	86	81	79	79	77	75	41	85	79	43	73	64	58	48	
763/763	.50	81	78	76	76	74	73	37	77	71	65	66	59	51	38	
	1.00	81	78	76	76	74	73	37	77	71	66	66	60	51	38	
	1.50	81	78	76	76	74	74	37	77	71	66	67	60	51	39	
	3.00	81	78	77	77	76	75	38	79	72	68	69	61	55	41	
0/1525	—	80	77	75	75	73	72	36	77	70	63	64	58	49	37	
1200/0	.13	78	74	73	72	70	69	33	75	68	61	61	54	46	35	
	.50	78	75	74	73	71	69	34	76	69	63	64	56	47	36	
	1.00	78	75	74	73	71	69	34	78	71	65	65	57	48	39	
	1.50	78	75	74	73	71	69	34	79	72	66	67	58	50	40	
	3.00	81	77	75	74	72	70	36	80	74	70	70	61	56	42	
600/600	.50	78	74	72	72	69	69	34	73	67	61	62	54	46	34	
	1.00	78	74	72	72	69	69	34	73	67	62	63	55	47	35	
	1.50	78	74	73	72	69	69	34	73	67	63	64	55	49	36	
	3.00	78	74	73	73	70	69	34	76	69	65	67	58	53	39	
0/1200	—	78	72	72	72	69	68	31	73	64	60	60	54	45	32	
900/0	.08	70	65	66	65	62	60	24	66	59	56	55	48	38	26	
	.50	71	66	67	66	62	61	25	69	63	59	59	49	40	31	
	1.00	72	68	68	68	64	62	26	73	66	61	61	52	43	33	
	1.50	74	69	69	68	64	62	27	73	67	63	63	54	47	35	
	3.00	76	71	70	69	66	63	29	75	70	67	68	58	54	40	
450/450	.50	72	66	66	66	63	62	26	66	60	57	57	48	39	28	
	1.00	70	66	67	66	63	61	25	67	61	58	58	49	42	30	
	1.50	69	65	67	67	63	61	25	68	62	60	60	51	45	32	
	3.00	71	66	68	67	64	62	26	71	64	61	64	55	51	36	
0/900	—	69	64	66	65	62	61	25	67	58	55	56	48	38	27	

- NOTES:**
1. ΔP_s static pressure difference from inlet to discharge.
 2. ΔP_s is the minimum required to deliver CFM shown in the primary damper in open position.
 3. ΔP_s does not include hot water or electric coils.
 4. Dash (-) indicates NC level less than 10.

NC levels are derived from tests conducted in accordance with ARI Standard 880-98 and are calculated in accordance with Appendix E of ARI Standard 885-98 as application data based on the following:

Discharge NC levels are based on -

- a) 5 foot rectangular duct lined with 1" fiberglass insulation.
- b) 5 foot lined flex duct (8" diameter).
- c) Maximum of 300 CFM per outlet.
- d) Space effect factor (2400 ft³) at 5 feet from outlet.
- e) End reflection.
- f) Environment adjustment factor.

Radiated NC levels are based on -

- a) Plenum/ceiling effect - solid gypsum board.
- b) Environment adjustment factor.



ARI Standard 880
A Participating Member
in the ARI 880
Certification Program

FAN CURVES CFM vs EXTERNAL STATIC PRESSURE

FAN SIZE A - UNDERFLOOR AC U1
1/6 H.P. Motor

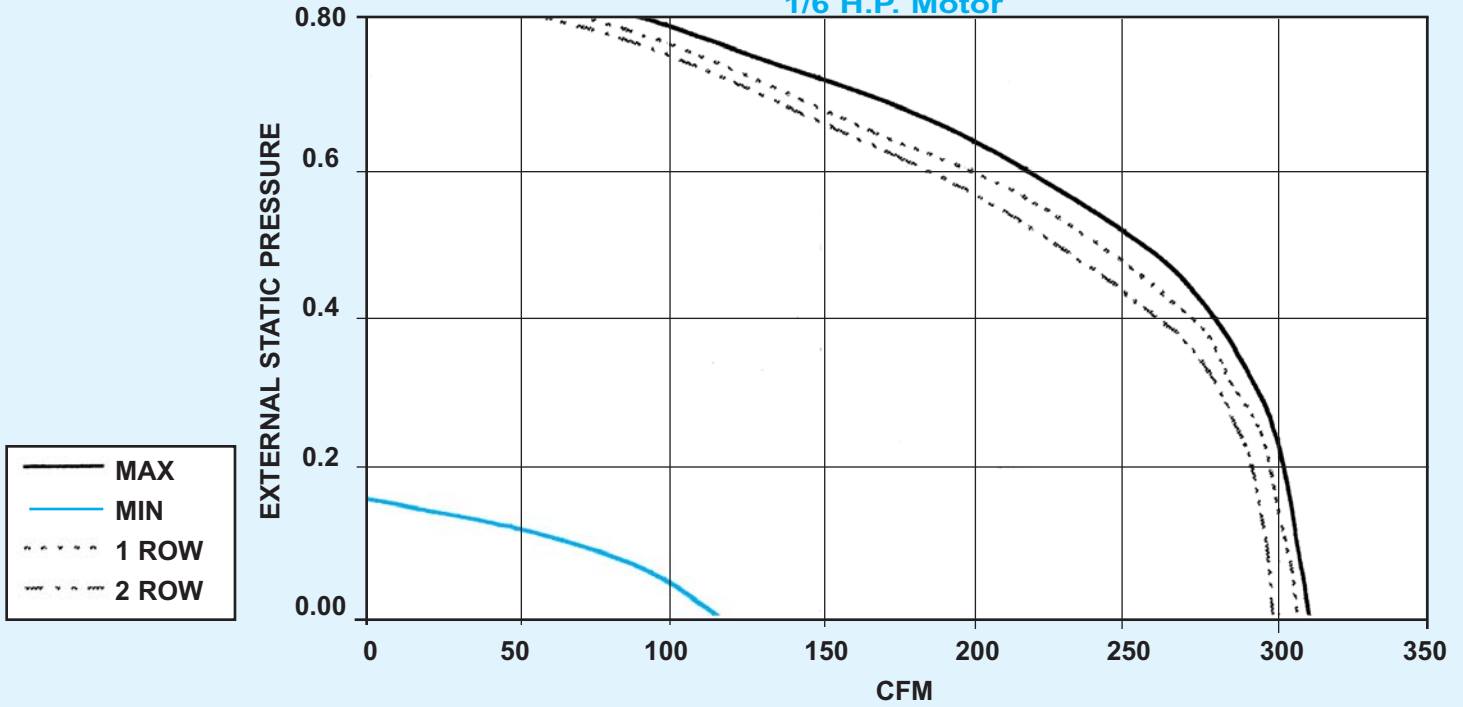

FAN POWERED UNITS

FAN SIZE B - UNDERFLOOR AC U2
1/6 H.P. Motor

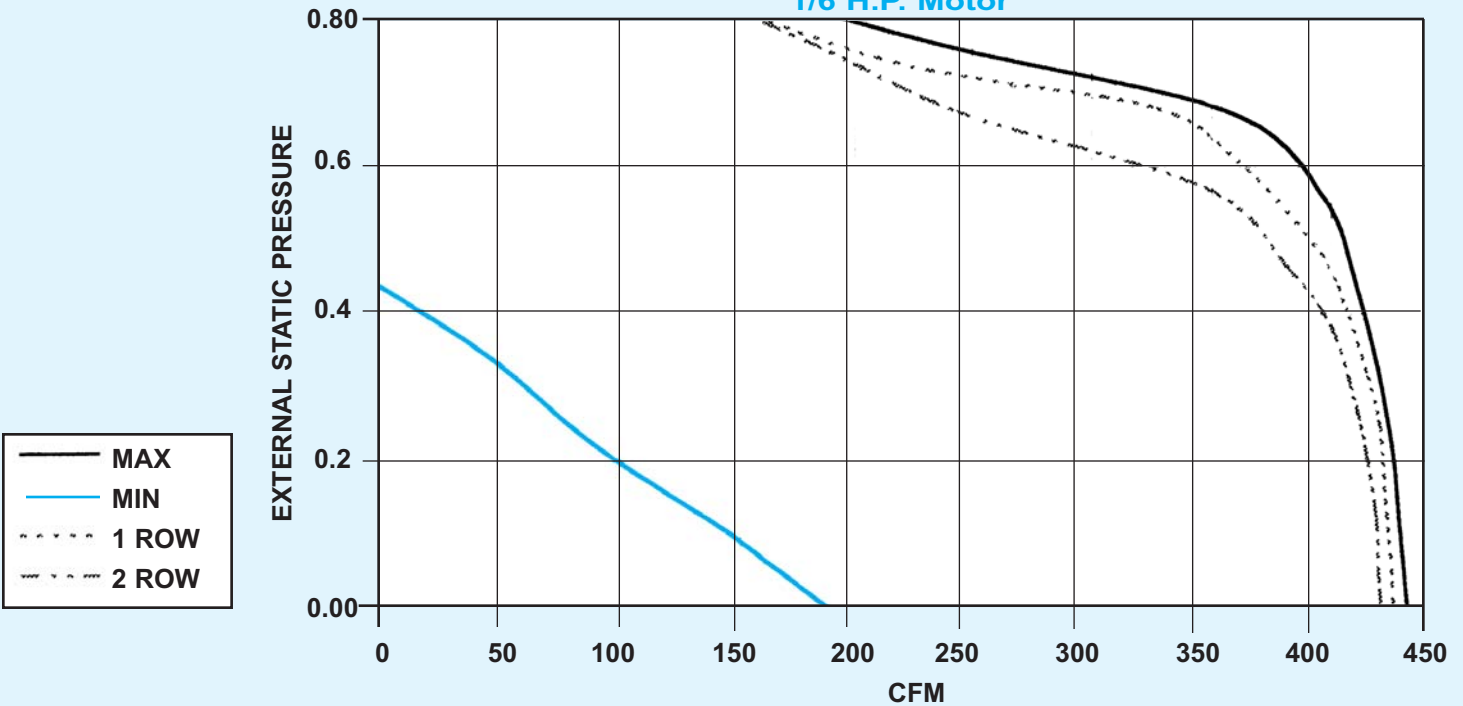

- NOTES:**
1. External static pressure (ESP) consists of down stream duct work, coils, flex duct, etc.
 2. Pressure drop due to heating coils are treated as external static pressure
 3. For proper operation, the downstream ESP must be at least 0.20" W.G.

FAN CURVES CFM vs EXTERNAL STATIC PRESSURE

FAN POWERED UNITS

FAN SIZE C - UNDERFLOOR AC U3
1/6 H.P. Motor

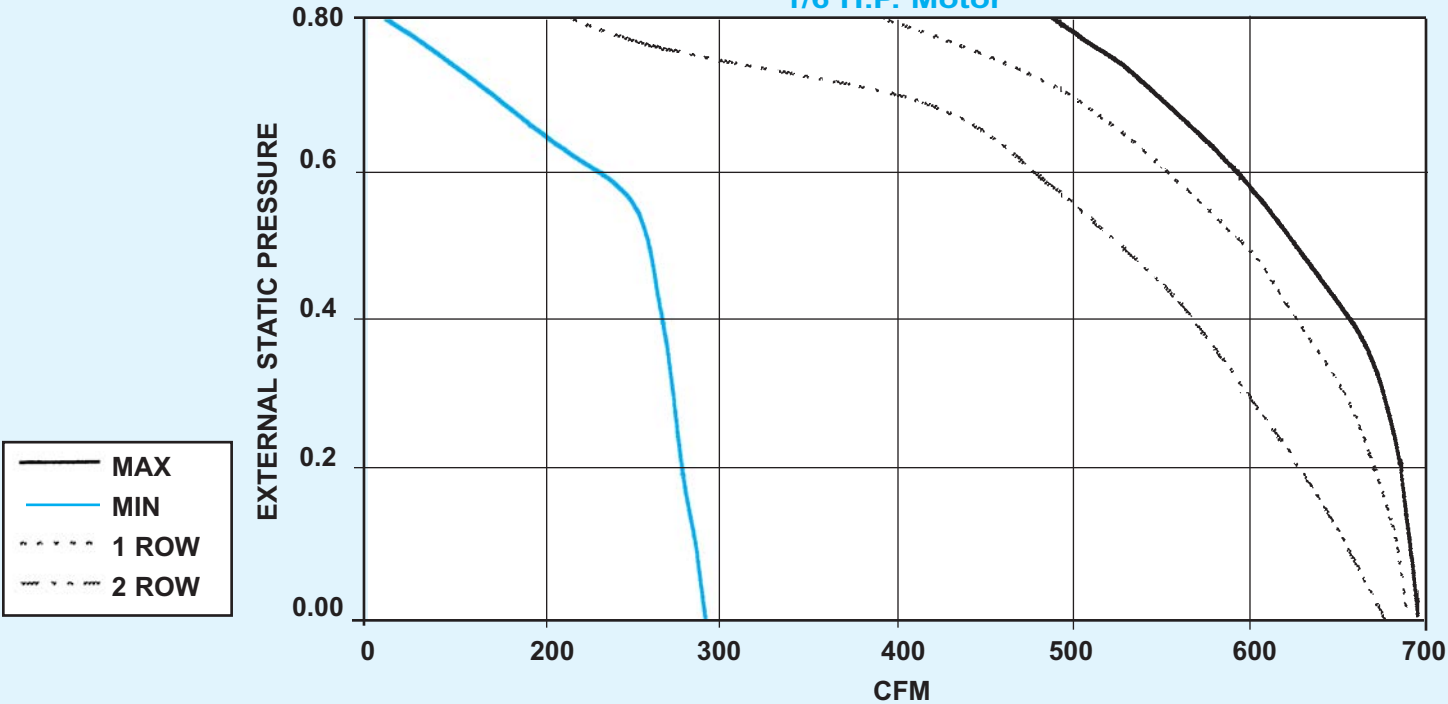

FAN SIZE D - UNDERFLOOR AC U4
1/4 H.P. Motor

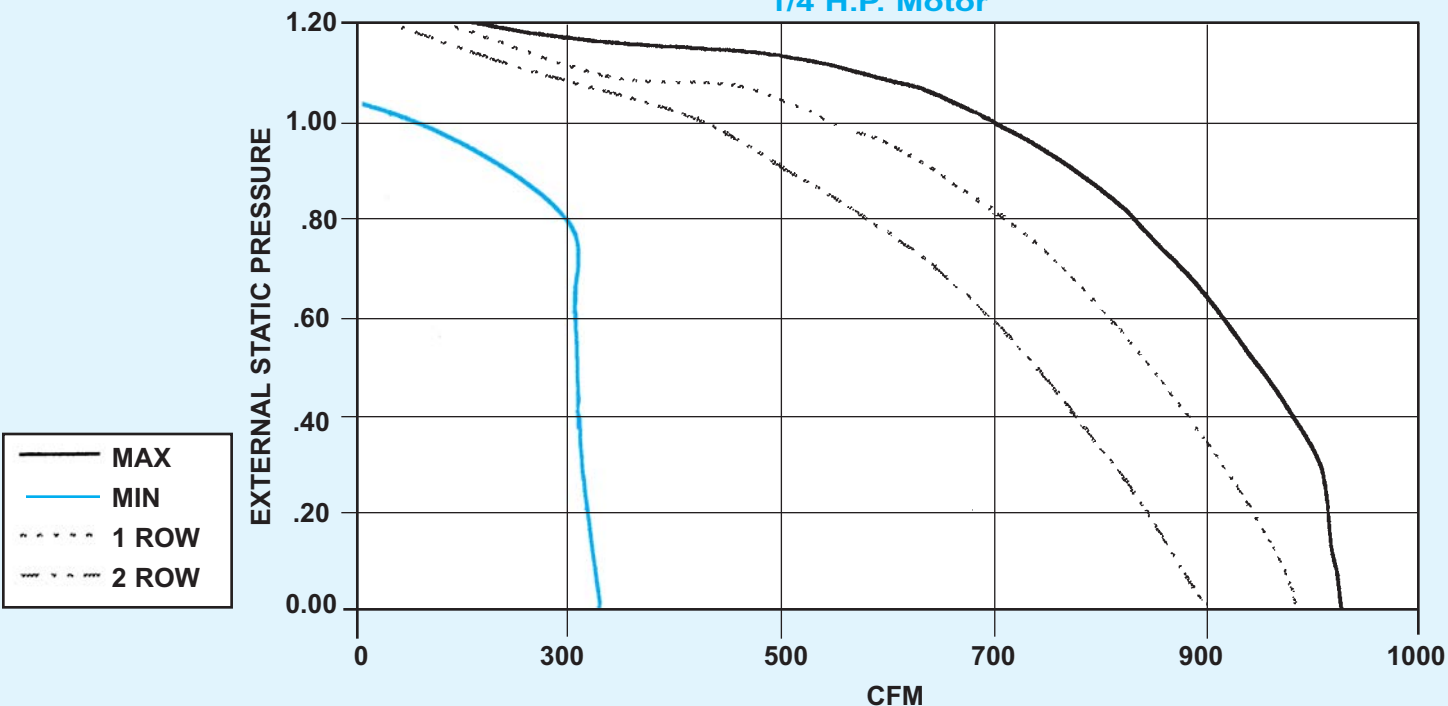

- NOTES:**
1. External static pressure (ESP) consists of down stream duct work, coils, flex duct, etc.
 2. Pressure drop due to heating coils are treated as external static pressure
 3. For proper operation, the downstream ESP must be at least 0.20" W.G.

FAN CURVES CFM vs EXTERNAL STATIC PRESSURE

FAN SIZE E - UNDERFLOOR AC U5
1/4 H.P. Motor

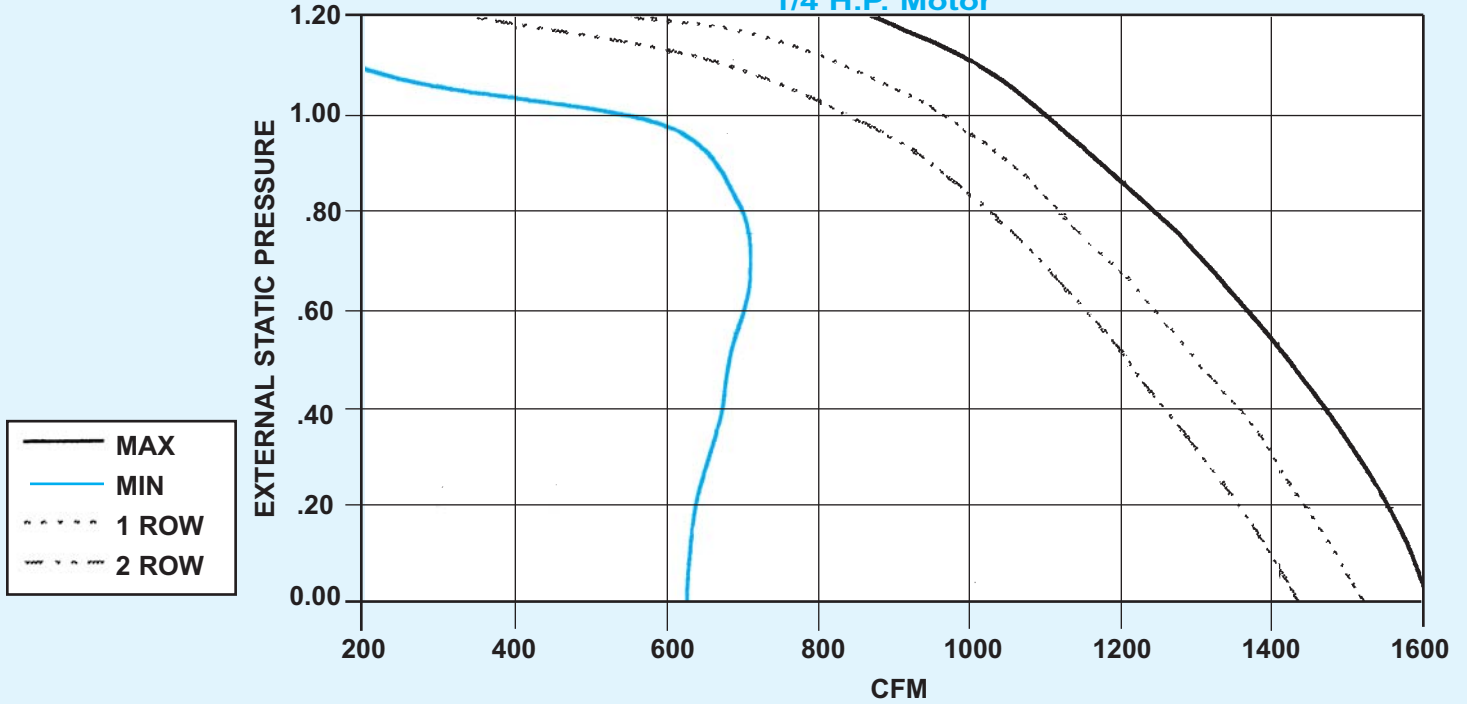

FAN POWERED UNITS

- NOTES:**
1. External static pressure (ESP) consists of down stream duct work, coils, flex duct, etc.
 2. Pressure drop due to heating coils are treated as external static pressure
 3. For proper operation, the downstream ESP must be at least 0.20" W.G.

MODEL NUMBERING – Constant Volume (Series Flow), Underfloor Design

FAN POWERED UNITS

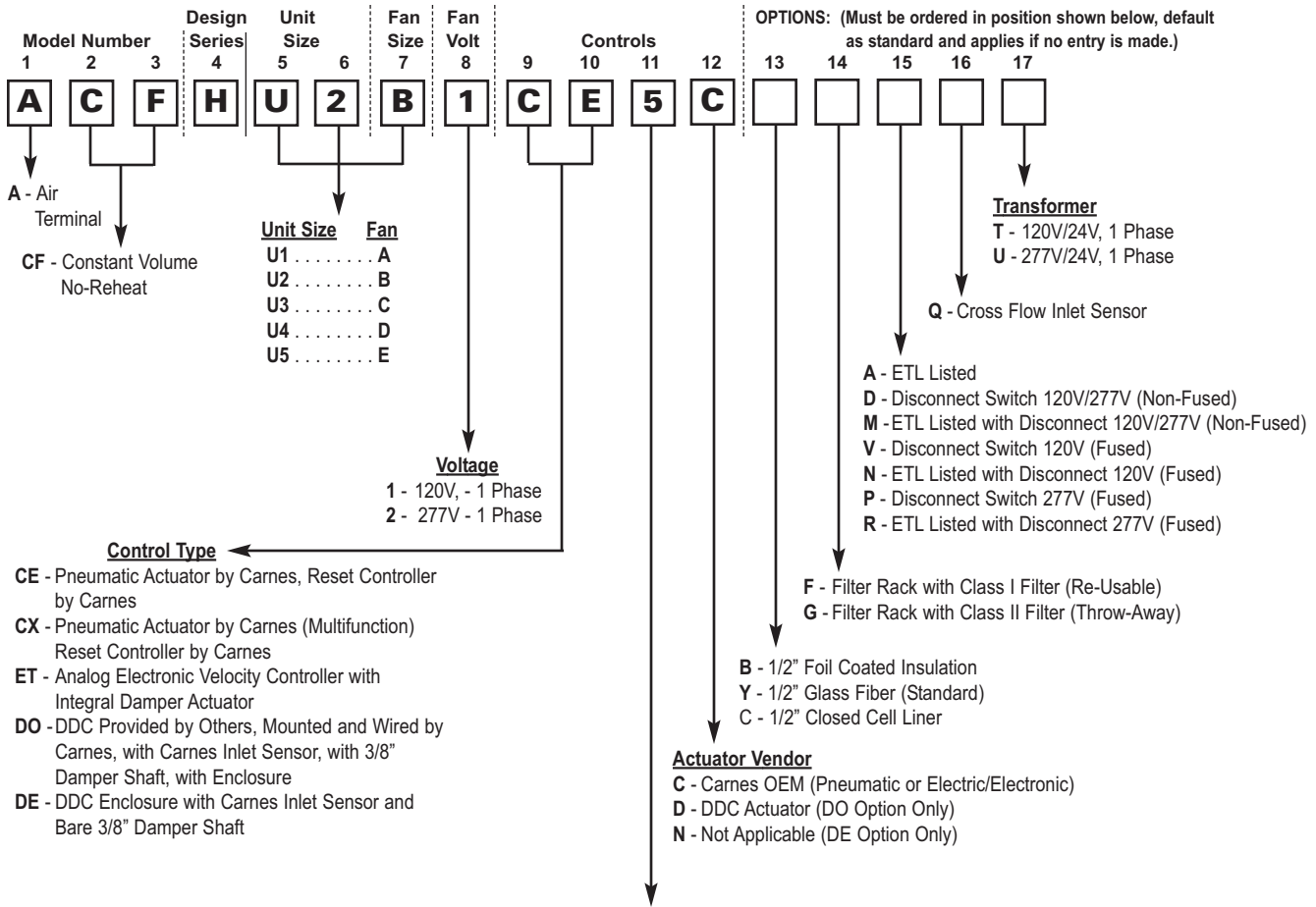

Controls and Damper Arrangement

NOTE: Hand of controls is determined by facing the averaging flow sensor (inlet of the unit) with the supply air hitting the back of your head.

- *1 - Normally Open - Right Hand Controls (Electronic/DO, DE & ET) (All Pneumatic Control Types for Reverse Acting Thermostat)
- 3 - Normally Closed - Right Hand Controls (All Pneumatic Control Types for Direct Acting Thermostat)
- 5 - Normally Open - Right Hand Controls (All Pneumatic Control Types for Direct Acting Thermostat)
- 7 - Normally Closed - Right Hand Controls (All Pneumatic Control Types for Reverse Acting Thermostat)

Electronic Thermostat

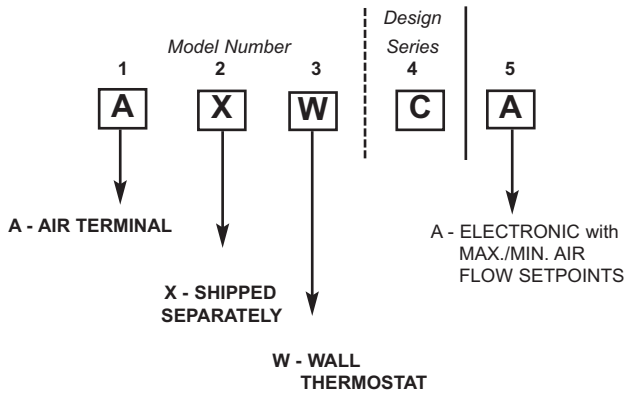

*Electronic and DDC Units DO NOT Fail Open, "1" is used for Right Hand Only. Electronic Units are shipped with the Damper in Open Position.

A Carnes Electronic Thermostat **must be ordered** with the Electronic ET Control Option.

DIMENSIONAL DATA - Constant Volume (Series Flow), Underfloor Design

Model ACFH

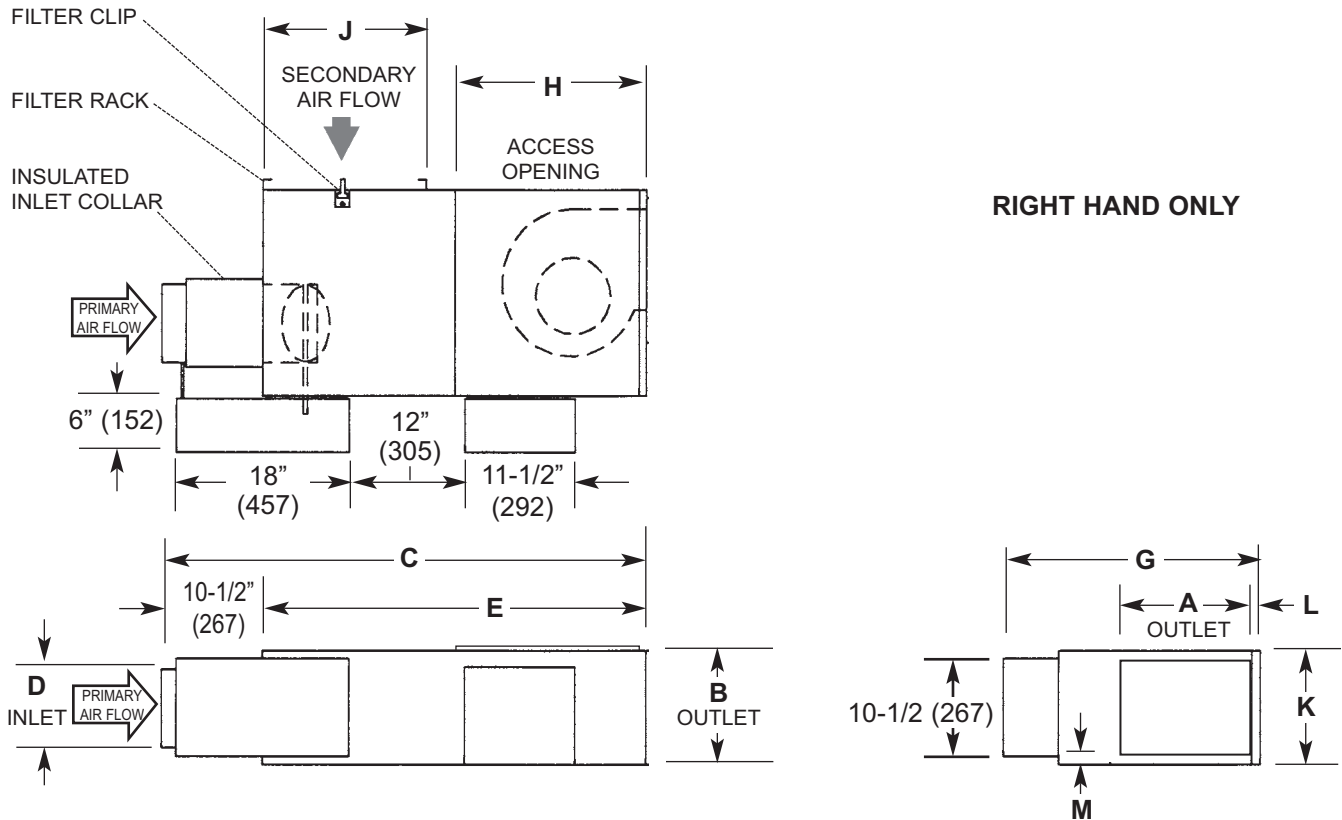

DIMENSIONS LISTED IN INCHES (Millimeters)

Unit Size	Fan Size	Inlet Size	Primary CFM (L/s)	Secondary CFM(L/s)@ .25 E.S.P.	Fan H.P.	Outlet		C	Inlet		E	G	H	J	K	L	M
						A	B		D								
U1	A	05	350 (165)	290 (137)	1/6				4-7/8 (124)								
U2	B	06	500 (236)	420 (198)	1/6	9-1/2 (241)	7 (178)	50-1/2 (1283)	5-7/8 (149)	40 (1016)	27 (685)	19-1/4 (489)	16 (406)	10-1/2 (267)	2-1/2 (64)		1-1/4 (32)
U3	C	07	700 (330)	680 (321)	1/6				6-7/8 (175)								
U4	D	08	1000 (472)	1000 (472)	1/4	10 (254)	7 (178)		7-7/8 (200)							1-3/4 (44)	
U5	E	10	1500 (708)	1525 (720)	1/2	11 (279)	8-1/4 (210)	50-1/2 (1283)	9-7/8 (251)	40 (1016)	27 (685)	19-1/4 (489)	17 (432)	12-1/2 (318)	2 (51)	2 (51)	

NOTE: Outlet dimensions refer to the actual opening.

MODEL NUMBERING – Constant Volume (Series Flow), Underfloor Design

FAN POWERED UNITS

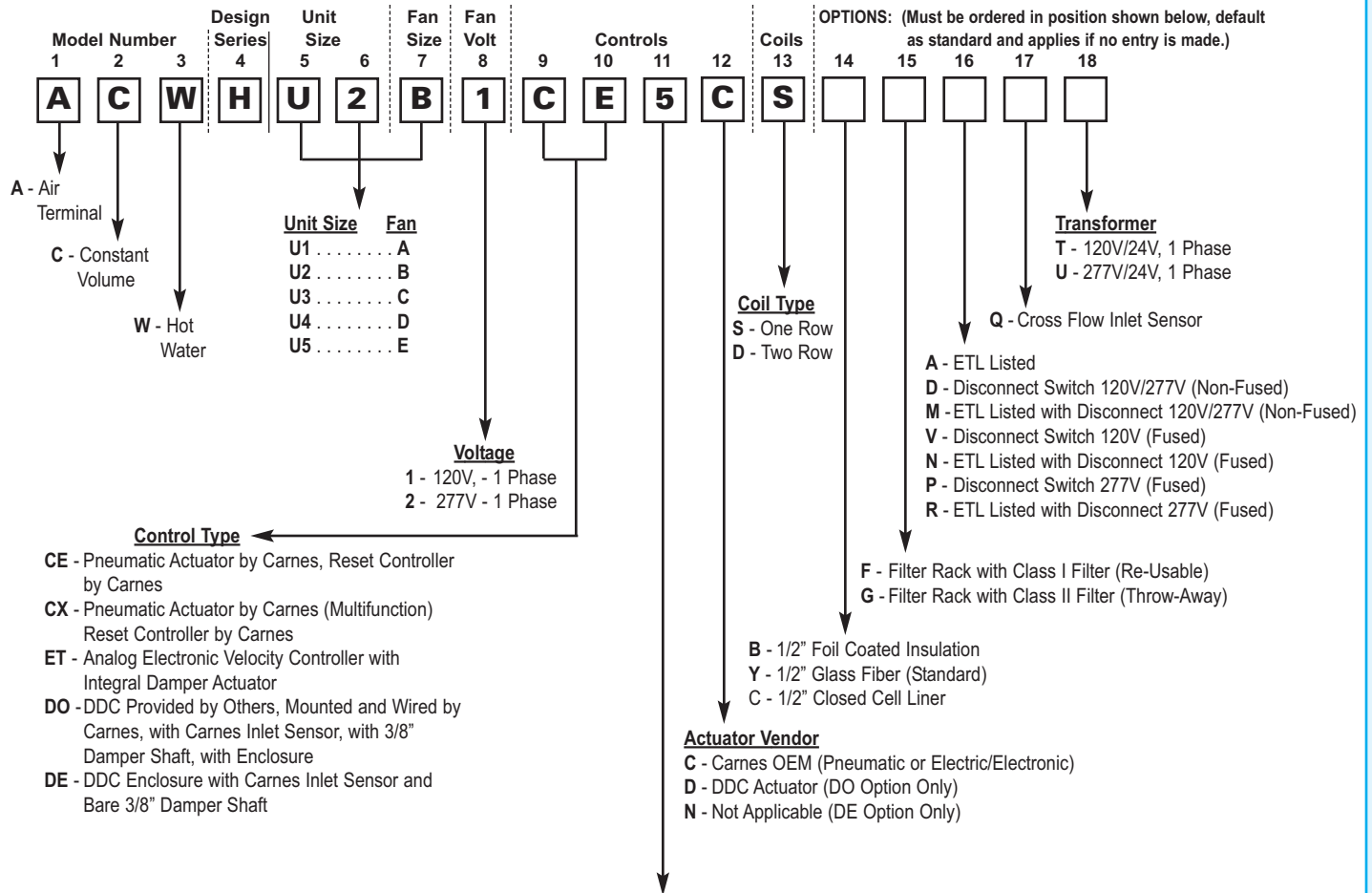

Controls and Damper Arrangement

NOTE: Hand of controls is determined by facing the averaging flow sensor (inlet of the unit) with the supply air hitting the back of your head.

- *1 - Normally Open - Right Hand Controls (Electronic/DO, DE & ET) (All Pneumatic Control Types for Reverse Acting Thermostat)
- 3 - Normally Closed - Right Hand Controls (All Pneumatic Control Types for Direct Acting Thermostat)
- 5 - Normally Open - Right Hand Controls (All Pneumatic Control Types for Direct Acting Thermostat)
- 7 - Normally Closed - Right Hand Controls (All Pneumatic Control Types for Reverse Acting Thermostat)

Electronic Thermostat

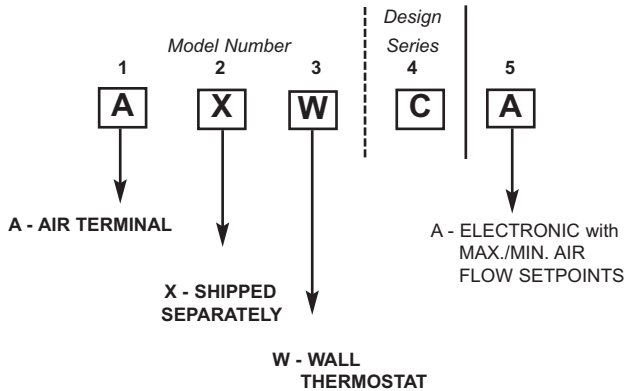

*Electronic and DDC Units DO NOT Fail Open, "1" is used for Right Hand Only. Electronic Units are shipped with the Damper in Open Position.

A Carnes Electronic Thermostat **must be ordered** with the Electronic ET Control Option.

DIMENSIONAL DATA - Constant Volume (Series Flow), Underfloor Design

Model ACWH

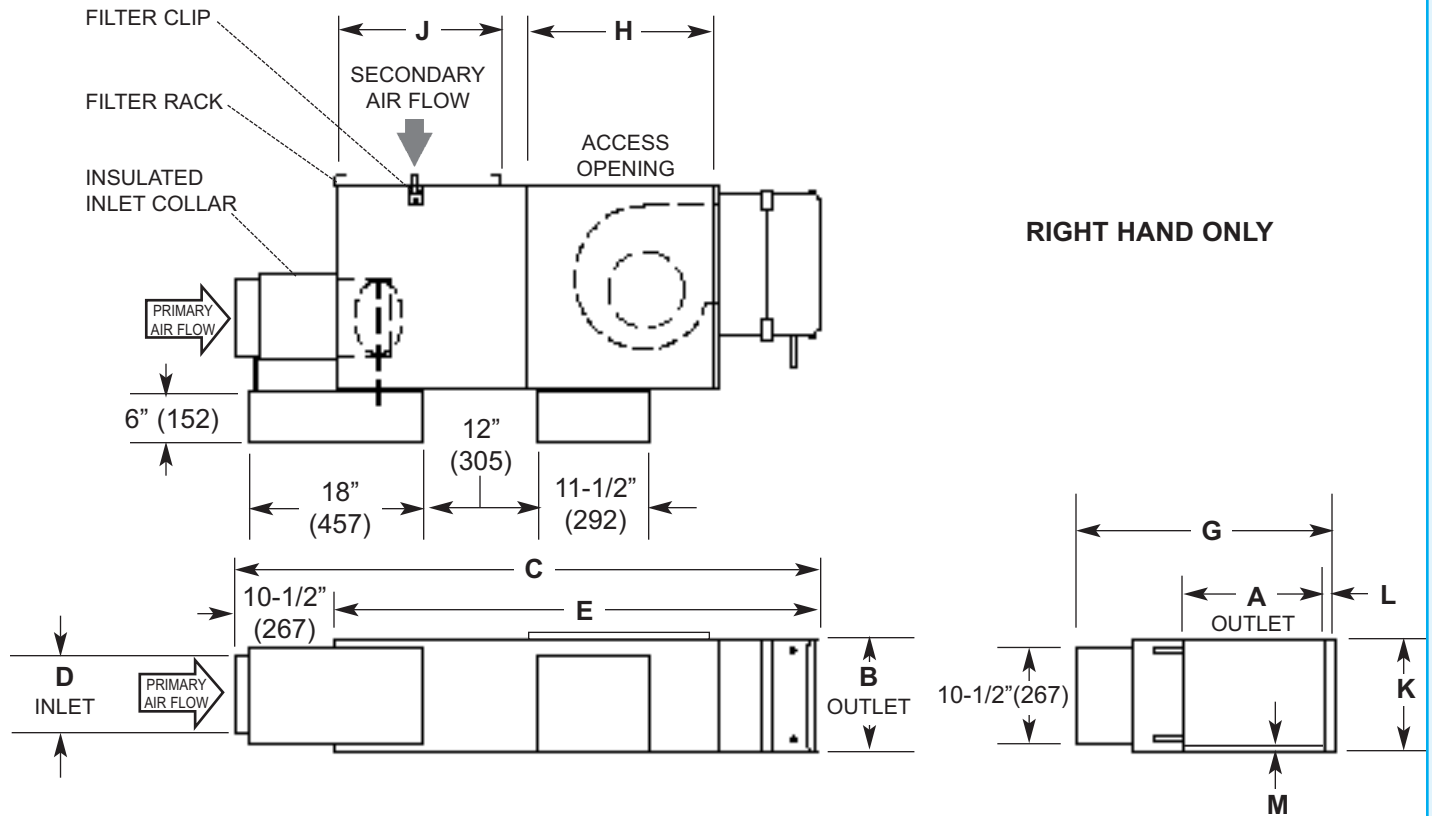

DIMENSIONS LISTED IN INCHES (Millimeters)

Unit Size	Fan Size	Inlet Size	Primary CFM (L/s)	Secondary CFM (L/s) @ .25 E.S.P.	Fan H.P.	Outlet		C 1-Row	C 2-Row	Inlet D	E 1-Row	E 2-Row	G	H	J	K	L	M
						A	B											
U1	A	05	350 (165)	290 (137)	1/6					4-7/8 (124)								
U2	B	06	500 (236)	420 (198)	1/6	12 (305)	10 (254)	56-1/2 (1435)	58 (1473)	5-7/8 (149)	46-1/8 (1172)	47-1/2 (1207)	27 (685)	19-1/4 (489)	16 (406)	10-1/2 (267)	1/2 (13)	1/2 (13)
U3	C	07	700 (330)	680 (321)	1/6					6-7/8 (175)								
U4	D	08	1000 (472)	1000 (472)	1/4					7-7/8 (200)							1/2 (13)	
U5	E	10	1500 (708)	1525 (720)	1/2	14 (356)	12-1/2 (318)	56-1/2 (1435)	58 (1473)	9-7/8 (251)	46-1/8 (1172)	47-1/2 (1207)	27 (685)	19-1/4 (489)	17 (432)	12-1/2 (318)	--	--

NOTE: Outlet is designed for slip and drive duct connection.

MODEL NUMBERING - Constant Volume (Series Flow), Underfloor Design

FAN POWERED UNITS

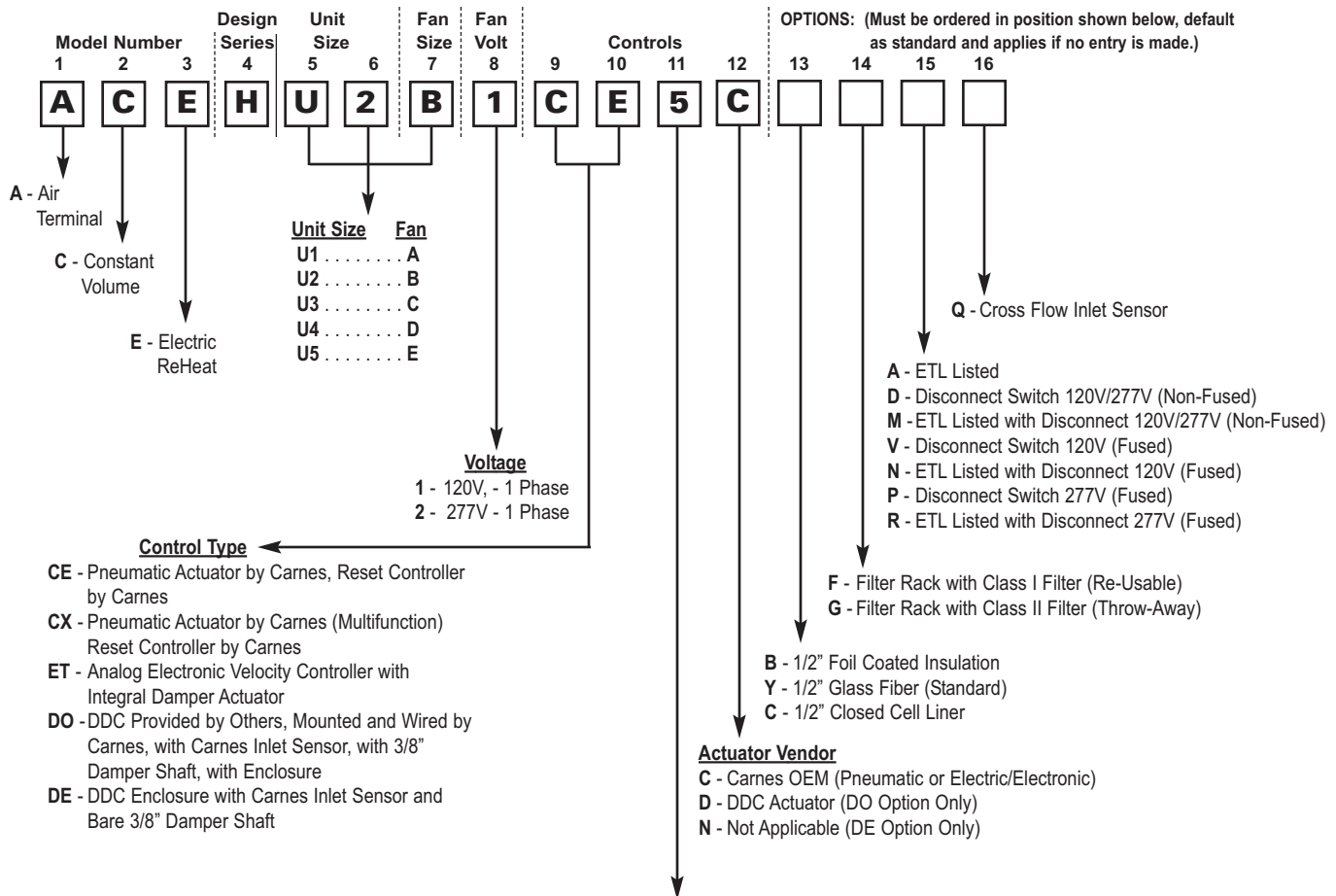

Controls and Damper Arrangement

NOTE: Hand of controls is determined by facing the averaging flow sensor (inlet of the unit) with the supply air hitting the back of your head.

- *1 - Normally Open - Right Hand Controls (Electronic/DO, DE & ET) (All Pneumatic Control Types for Reverse Acting Thermostat)
- 3 - Normally Closed - Right Hand Controls (All Pneumatic Control Types for Direct Acting Thermostat)
- 5 - Normally Open - Right Hand Controls (All Pneumatic Control Types for Direct Acting Thermostat)
- 7 - Normally Closed - Right Hand Controls (All Pneumatic Control Types for Reverse Acting Thermostat)

Electronic Thermostat

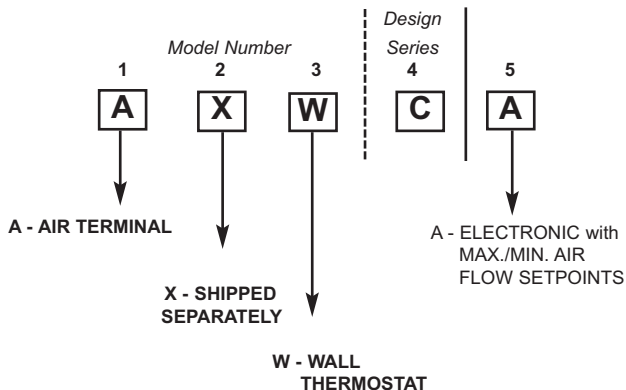

*Electronic and DDC Units DO NOT Fail Open, "1" is used for Right Hand Only. Electronic Units are shipped with the Damper in Open Position.

A Carnes Electronic Thermostat **must be ordered** with the Electronic ET Control Option.

DIMENSIONAL DATA - Constant Volume (Series Flow), Underfloor Design

Model ACEH

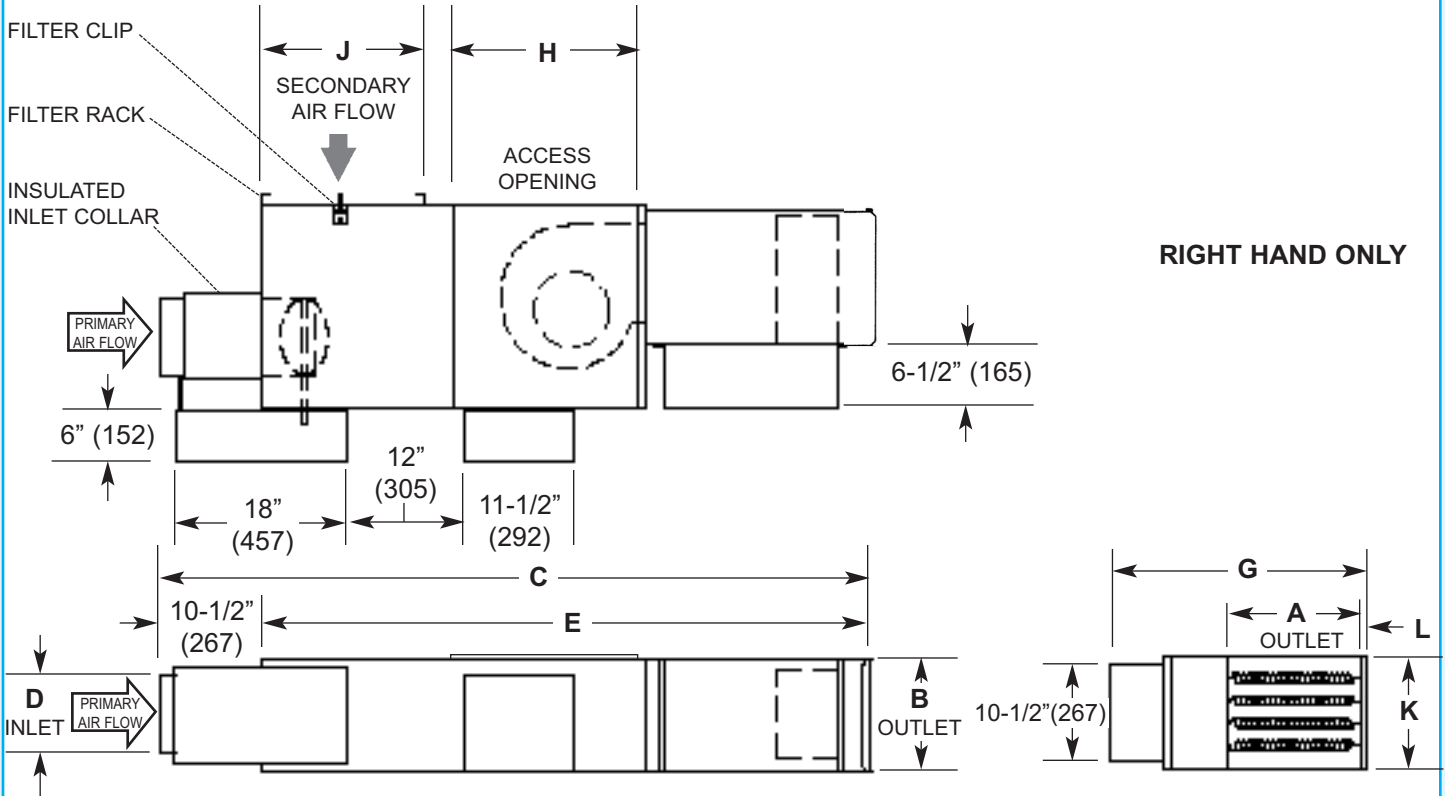

DIMENSIONS LISTED IN INCHES (Millimeters)

Unit Size	Fan Size	Inlet Size	Primary CFM (L/s)	Secondary CFM (L/s) @ .25 E.S.P.	Fan H.P.	Outlet		C	Inlet		E	G	H	J	K	L
						A	B		D							
U1	A	05	350 (165)	290 (137)	1/6				4-7/8 (124)							
U2	B	06	500 (236)	420 (198)	1/6	12 (305)	10-1/2 (267)	72-3/4 (1848)	5-7/8 (149)	62-1/4 (1581)	27 (685)	19-1/4 (489)	16 (406)	10-1/2 (267)	1 (25)	
U3	C	07	700 (330)	680 (321)	1/6				6-7/8 (175)							
U4	D	08	1000 (472)	1000 (472)	1/4				7-7/8 (200)						1-1/2 (38)	
U5	E	10	1500 (708)	1525 (720)	1/2	14 (356)	12-1/2 (318)	72-3/4 (1848)	9-7/8 (251)	62-1/4 (1581)	27 (685)	19-1/4 (489)	17 (432)	12-1/2 (318)	--	

NOTE: Outlet is designed for slip and drive duct connection.

FAN POWERED UNITS

FAN TERMINAL UNITS – Intermittent Volume (Parallel Flow), Low Profile Design

Model **ASF w/o Reheat**
 ASW w/ Hot Water Reheat
 ASE w/ Electric Reheat

The **Carnes** low profile intermittent fan terminal unit provides constant air volume to the space for reheat applications while retaining a variable air volume system during normal cooling operation.

The primary air control assembly operates independently as a standard throttling valve for cooling loads. As cooling loads diminish, the secondary air supply fan(s) is energized to induce warm ceiling plenum air. A wide variety of control sequences makes this fan powered unit compatible with the most energy efficient system design.

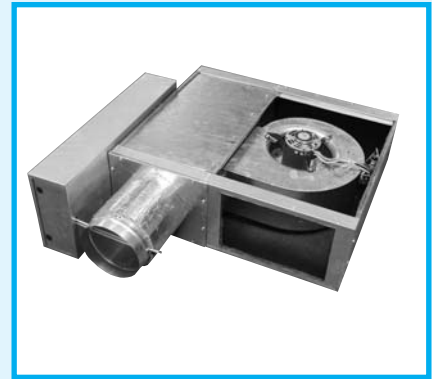

Features Include:

- Four unit sizes offering air flow capacities to 2100 CFM primary air and 1800 CFM secondary air with low pressure drop and low sound levels.
- Durable 22 gauge galvanized steel casing construction.
- Access to internal components.
- Standard inlet and flange or slip and drive discharge connections.
- Forward curved centrifugal type fan assemblies with 120 or 277 volt fractional horsepower PSC motors.
- Fan/motor assemblies are isolated from the casing using rubber isolators to minimize vibration transmission.
- Field adjustable P/E switch with pneumatic controls.
- Performance data based on tests conducted in accordance with ARI Standard 880-98.
- Averaging type velocity sensor and calibration chart for measuring primary air flow.
- Pneumatic or electronic pressure independent controls available.
- Insulation is 1/2" thick, 2.0 lb. dual density fiberglass with surface treated to prevent air erosion, UL listed and meets NFPA 90A requirements.
- Low leakage primary air damper design.
- Optional primary air controls enclosure.
- Optional secondary air sound baffle. Sound baffle is factory attached to secondary air inlet.
- Optional one or two row hot water coils (Model ASW). Coil is factory attached to primary air discharge.
- Optional one, two or three stage electric reheat coils (Model ASE). Coil is factory attached to primary air discharge, or shipped separately for field mounting.
- Optional secondary air filters, Class I (re-usable) and Class II (throw away).
- Optional non-fused fan disconnect switch.
- Optional foil coated insulation (Hospital, Laboratory, etc. applications).
- Optional ETL listing.

Available Modules:

- Basic control unit — **Model ASF.**
- Basic control unit with hot water coil — **Model ASW.**
- Basic control unit with electric coil — **Model ASE.**



FAN CURVES CFM vs EXTERNAL STATIC PRESSURE

FAN SIZE A - AS L1, L2, L3
1/6 H.P. Motor

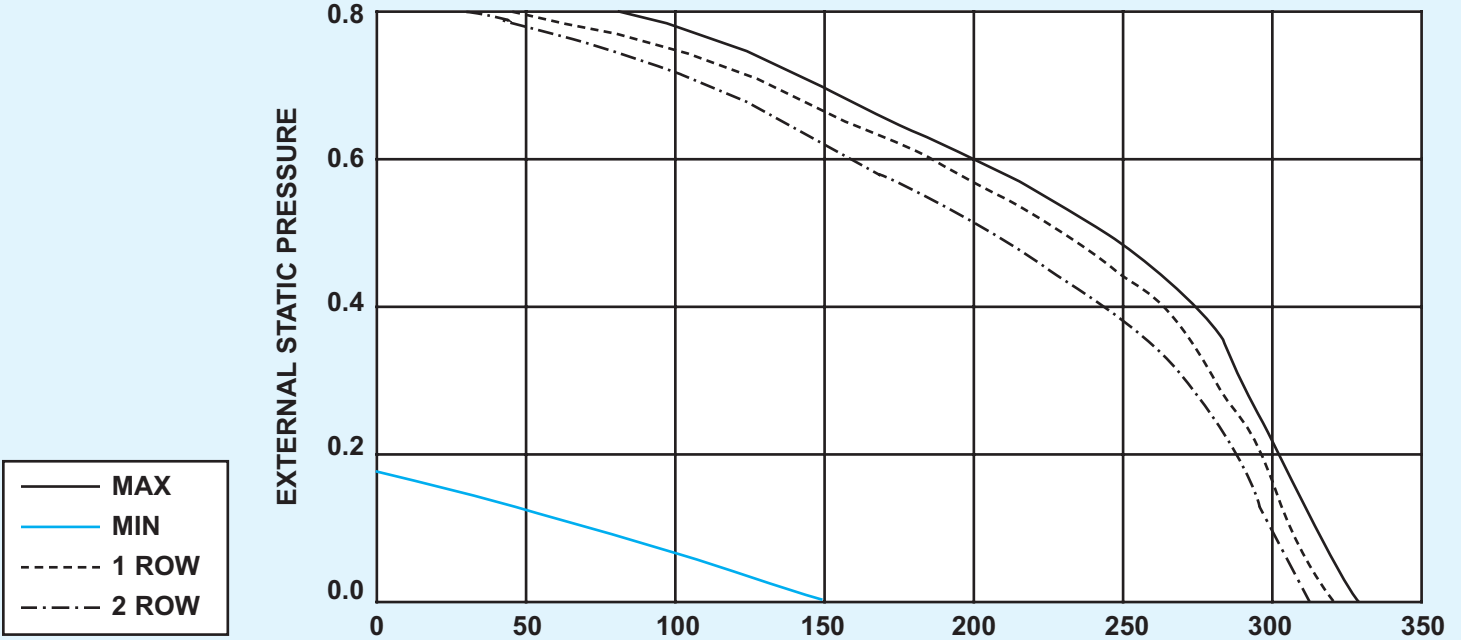

FAN POWERED UNITS

FAN SIZE B - AS L2, L3, L4
1/6 H.P. Motor

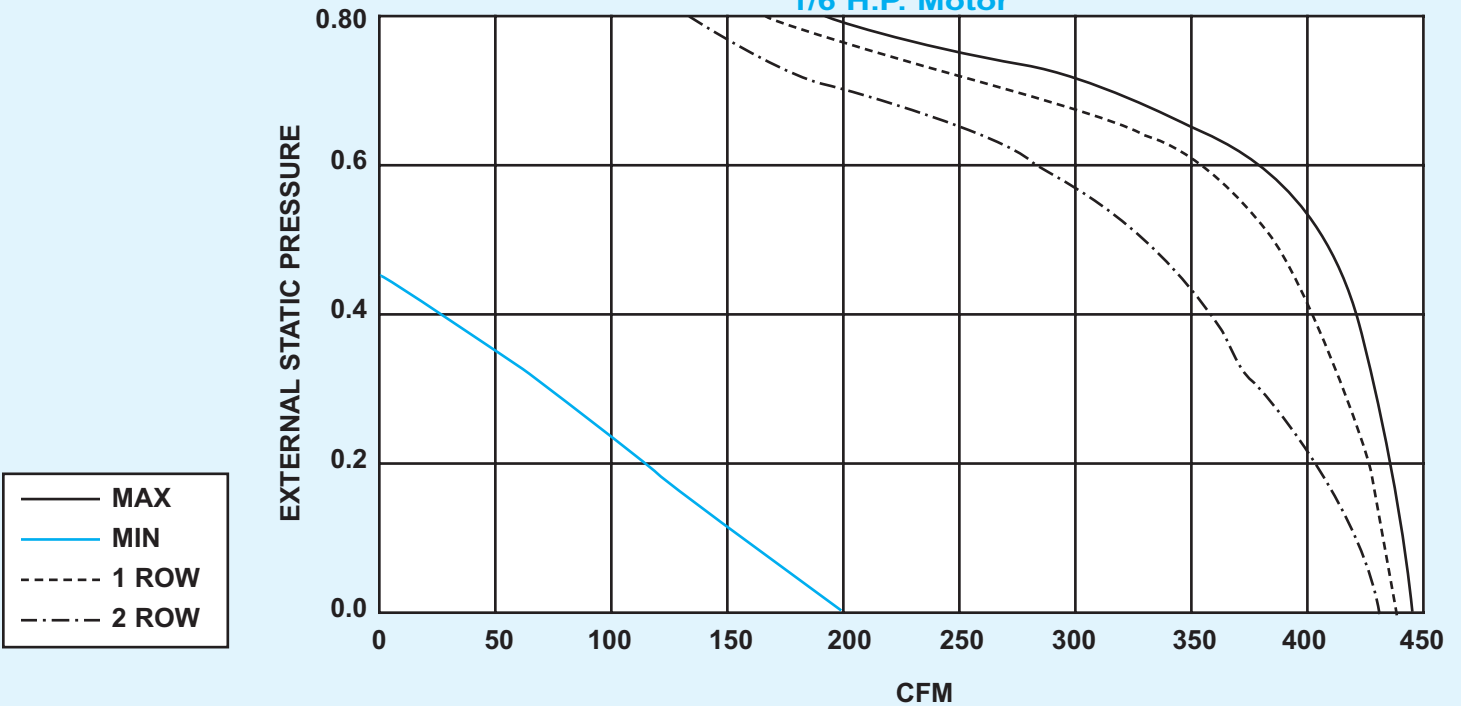

- NOTES:**
1. External static pressure (ESP) consists of down stream duct work, coils, flex duct, etc.
 2. Pressure drop due to heating coils are treated as external static pressure.
 3. For proper operation, the downstream ESP must be at least 0.20" W.G.

FAN CURVES CFM vs EXTERNAL STATIC PRESSURE

FAN POWERED UNITS

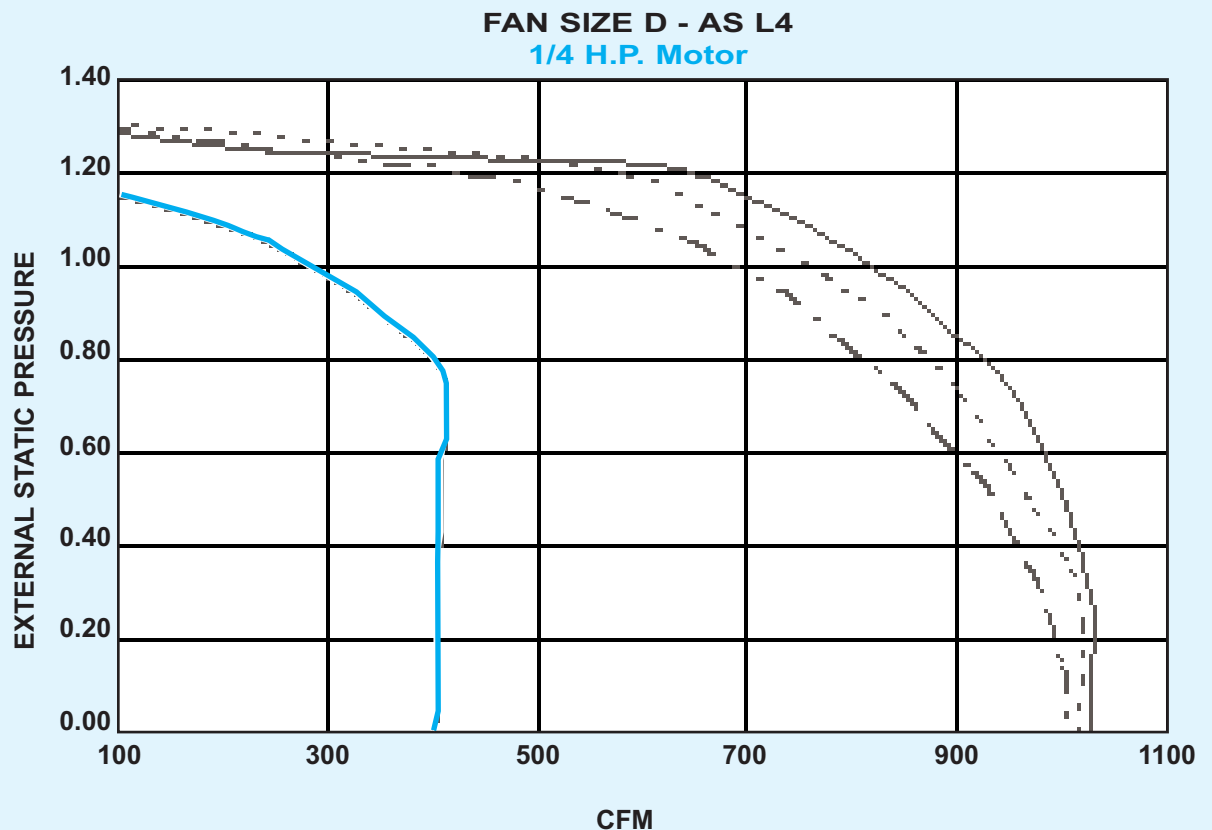
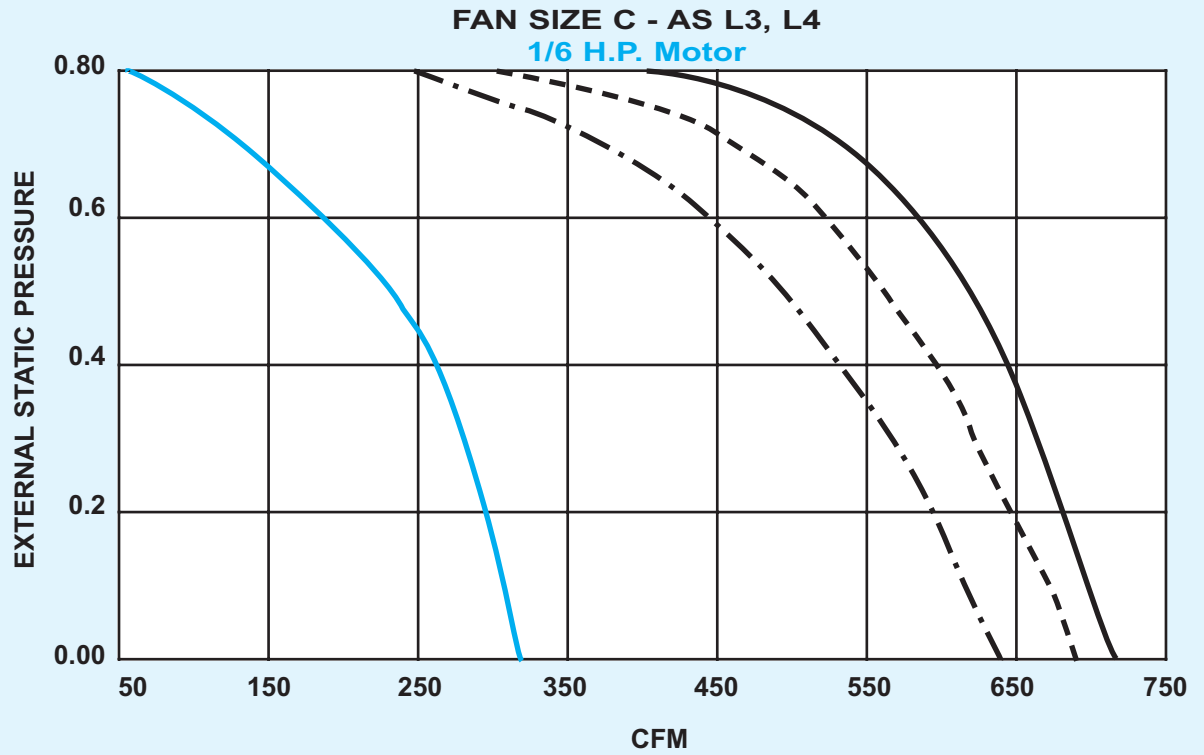

- NOTES:**
1. External static pressure (ESP) consists of down stream duct work, coils, flex duct, etc.
 2. Pressure drop due to heating coils are treated as external static pressure
 3. For proper operation, the downstream ESP must be at least 0.20" W.G.

FAN CURVES CFM vs EXTERNAL STATIC PRESSURE

FAN SIZE D - AS L5, L6
1/4 H.P. Motor

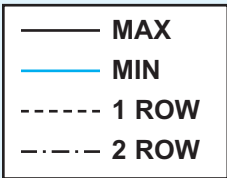
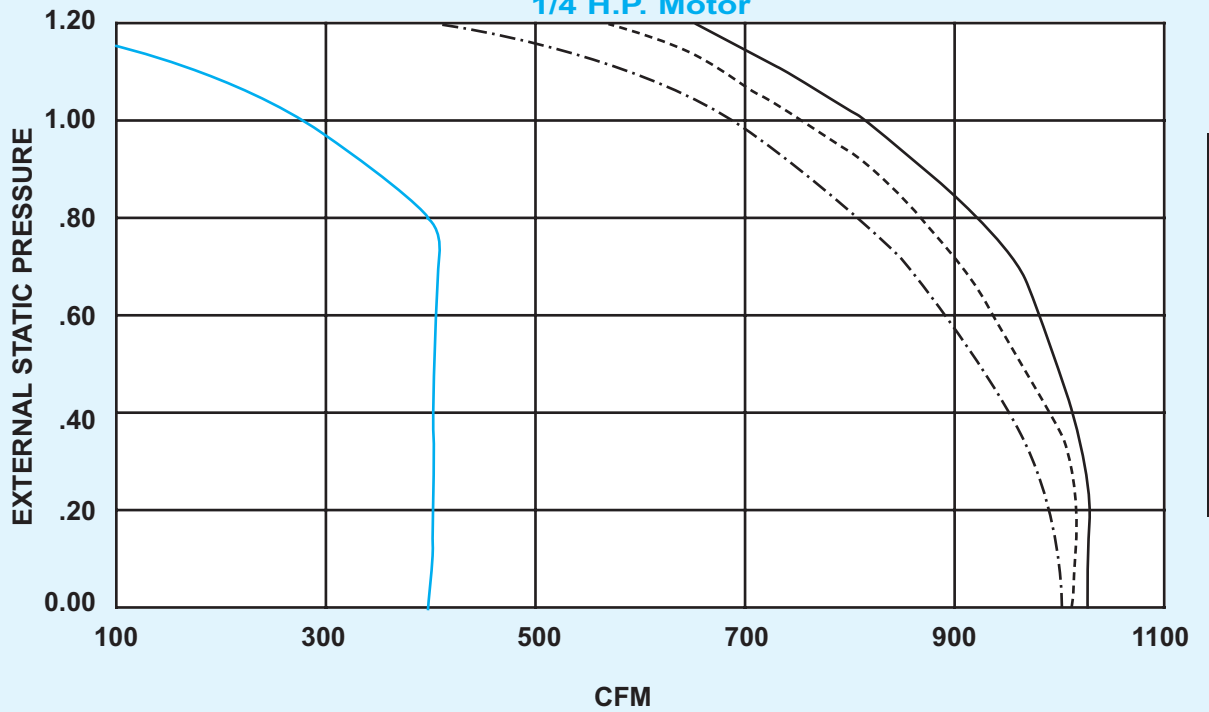

FAN POWERED UNITS

FAN SIZE E - AS L6
1/4 H.P. Motor

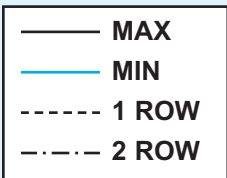
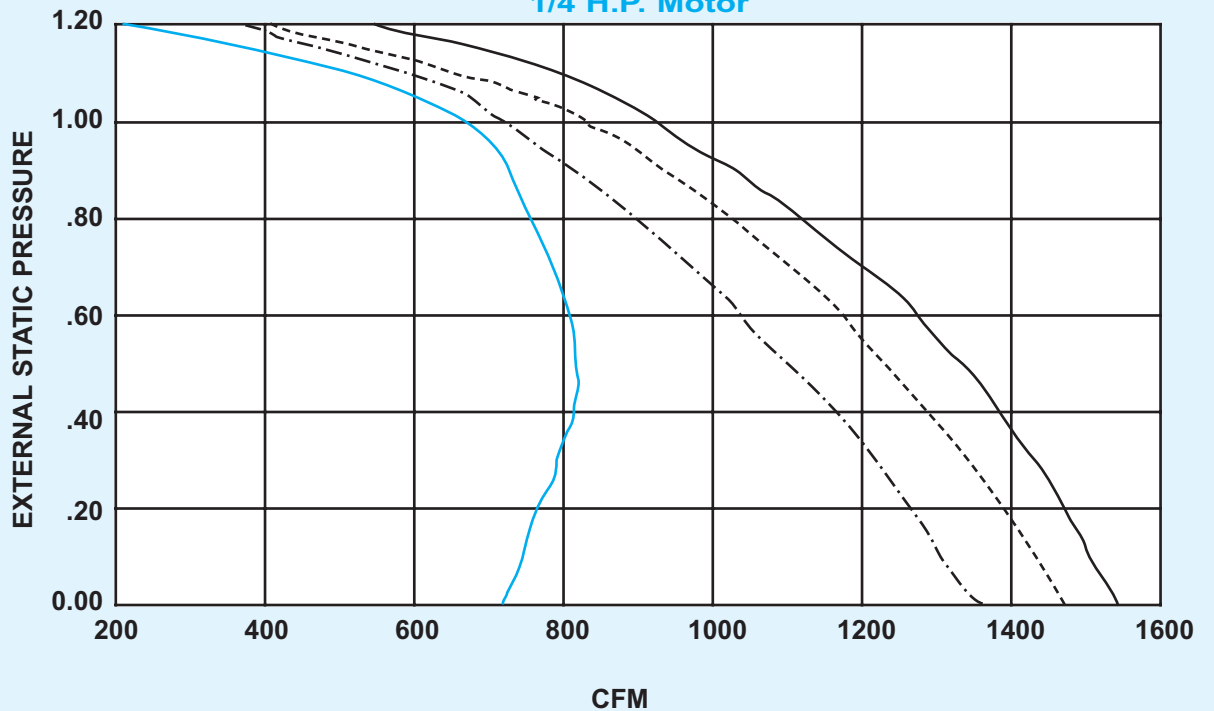

- NOTES:**
1. External static pressure (ESP) consists of down stream duct work, coils, flex duct, etc.
 2. Pressure drop due to heating coils are treated as external static pressure
 3. For proper operation, the downstream ESP must be at least 0.20" W.G.

PERFORMANCE DATA – Intermittent Volume (Parallel Flow), Low Profile Design

**DISCHARGE AND RADIATED (NC) NOISE CRITERIA
(FAN OFF - - 100% Primary Air)**

Model AS_H

FAN POWERED UNITS

Unit (Fan) Size	CFM	Minimum Pressure Drop			Min. ΔPs		1.0" ΔPs		1.5" ΔPs		3.0" ΔPs	
		Base Unit	1 - Row	2 - Row	Dis NC	Rad NC	Dis NC	Rad NC	Dis NC	Rad NC	Dis NC	Rad NC
L1 (A)	75	.013	.016	.023	--	--	--	--	--	--	--	19
	100	.021	.028	.035	--	--	--	--	--	--	10	19
	200	.084	.111	.137	--	--	10	--	11	10	12	19
	250	.180	.237	.292	--	--	19	14	19	15	19	20
	350	.247	.316	.383	--	--	19	15	19	17	22	21
L2 (A, B)	110	.007	.017	.026	--	--	--	--	--	11	--	21
	200	.022	.045	.077	--	--	--	--	--	11	11	21
	300	.044	.091	.148	--	--	11	--	13	12	16	21
	400	.075	.153	.246	--	--	13	14	15	15	18	22
	500	.119	.231	.365	--	--	18	18	19	19	22	22
L3 (A, B, C)	140	.002	.016	.037	--	--	--	--	--	--	10	19
	200	.004	.034	.057	--	--	--	--	--	10	11	20
	400	.009	.086	.175	--	--	--	10	12	13	16	20
	600	.023	.176	.356	14	--	16	17	18	19	22	23
	700	.029	.219	.448	14	--	18	18	21	22	24	24
L4 (B, C, D)	185	-.002	.018	.037	--	--	--	--	--	--	--	19
	400	-.007	.060	.157	--	--	10	10	15	14	18	21
	600	-.019	.129	.325	--	--	12	13	17	18	23	24
	800	-.037	.209	.510	11	--	15	17	18	21	24	26
	1000	-.062	.303	.761	16	--	19	20	21	23	27	28
L5 (D)	185	-.001	.008	.020	--	--	--	--	--	--	10	19
	400	-.004	.032	.064	--	--	--	--	12	13	15	21
	600	-.006	.062	.078	--	--	14	11	15	15	19	23
	800	-.011	.102	.206	--	--	16	15	18	19	23	25
	1000	-.020	.146	.301	--	--	19	19	22	23	25	27
L6 (D, E)	300	-.005	.017	.038	--	--	--	10	10	13	12	19
	500	-.012	.035	.089	--	--	--	12	12	16	16	21
	800	-.032	.071	.188	--	--	11	16	15	20	19	24
	1200	-.073	.139	.382	--	--	15	21	19	24	24	31
	1500	-.114	.202	.557	--	10	18	23	21	26	27	32

- NOTES:**
1. Δ Ps static pressure difference from inlet to discharge.
 2. Δ Ps is the minimum required to deliver CFM shown the primary damper in open position.
 3. Δ Ps does not include hot water or electric coils.
 4. Dash (--) indicates NC level less than 10.

NC level are derived from tests conducted in accordance with ARI Standard 880-98 and are calculated in accordance with ARI Standard 885-98 as application data based on the following:

Discharge NC level are based on –

- a) 5 foot rectangular 12" x 12" duct lined with 1" fiberglass insulation.
- b) 6 foot lined flex duct (8" diameter).
- c) Maximum of 300 CFM per outlet.
- d) Space effect factor (5000 ft³) at 10 feet from outlet.
- e) End reflection.
- f) Environmental adjustment factor.

Radiated NC levels are based on –

- a) Plenum/ceiling effect - 5/8" mineral fiber tile, 35 lb/ft³ - 3 foot plenum
- b) Space effect factor (5000 ft³) at 10 feet from source.
- c) Environmental adjustment factor.



ARI Standard 880
A Participating Member
in the ARI 880
Certification Program

PERFORMANCE DATA – Intermittent Volume (Parallel Flow), Low Profile Design

**DISCHARGE AND RADIATED SOUND DATA
(FAN ON — 100% Secondary Air)**

Model AS_H

Fan Size	Unit Size	ESP	CFM	Discharge Sound							Max. NC	Radiated Sound							
				Sound Power db								Max. NC	Sound Power db						
				Octave Band									Octave Band						
				2	3	4	5	6	7		2	3	4	5	6	7			
A	L1, L2, L3	.25	75	43	38	31	31	18	18	—	52	45	42	37	22	19	10		
		.25	150	45	38	34	35	21	18	—	55	49	46	41	28	19	14		
		.25	300	51	44	43	44	33	26	—	57	51	49	45	35	23	18		
B	L2, L3, L4	.25	200	47	40	39	38	24	20	—	56	51	48	45	34	22	16		
		.25	300	52	44	44	44	34	27	—	57	52	49	45	36	23	18		
		.25	430	57	51	51	51	42	37	—	61	56	53	50	42	31	22		
C	L3, L4	.25	300	51	44	43	43	32	24	—	57	51	49	45	35	23	18		
		.25	450	57	51	52	52	43	38	—	62	56	54	51	43	33	23		
		.25	660	65	58	58	60	51	49	17	67	62	59	57	50	42	28		
D	L4	.25	500	56	48	48	48	39	35	—	59	55	52	49	40	27	21		
		.25	750	65	57	56	59	50	49	14	65	62	60	57	50	40	30		
		.25	985	71	62	61	64	56	55	22	71	69	64	62	56	47	34		
D	L5, L6	.25	500	58	49	51	48	40	36	—	64	51	52	49	37	28	21		
		.25	750	62	52	57	56	48	46	10	68	58	58	58	48	42	30		
		.25	1000	69	59	62	63	56	55	19	74	65	63	62	54	50	34		
E	L6	.25	900	66	56	60	57	51	50	15	68	61	60	58	50	41	30		
		.25	1200	71	63	65	65	59	58	22	73	68	66	64	57	49	36		
		.25	1460	74	67	69	69	63	63	27	78	73	70	68	61	53	40		

NOTES: 1. External static pressure (ESP) is pressure due to back draft damper, heating coils and/or downstream ductwork.
2. The CFM indicated is the maximum attainable the external static pressure (ESP) shown. See fan curves for other ESP levels.

NC level are derived from tests conducted in accordance with ARI Standard 880-98 and are calculated in accordance with ARI Standard 885-98 as application data based on the following:

Discharge NC level are based on –

- a) 5 foot rectangular 12" x 12" duct lined with 1" fiberglass insulation.
- b) 6 foot lined flex duct (8" diameter).
- c) Maximum of 300 CFM per outlet.
- d) Space effect factor (5000 ft³) at 10 feet from outlet.
- e) End reflection.
- f) Environmental adjustment factor.

Radiated NC levels are based on –

- a) Plenum/ceiling effect - 5/8" mineral fiber tile, 35 lb/ft³ - 3 foot plenum
- b) Space effect factor (5000 ft³) at 10 feet from source.
- c) Environmental adjustment factor.



A Participating Member
in the ARI 880
Certification Program

FAN POWERED UNITS

PERFORMANCE DATA – Intermittent Volume (Parallel Flow), Low Profile Design

DISCHARGE SOUND DATA (Fan off - 100% Primary Air)

Model AS_H

FAN POWERED UNITS

Unit (Fan) Size	CFM	ΔPs	Minimum ΔPs							1.0" ΔPs							1.5" ΔPs							3.0" ΔPs						
			Sound Power (db) Octave Band							Sound Power (db) Octave Band							Sound Power (db) Octave Band							Sound Power (db) Octave Band						
			2	3	4	5	6	7	2	3	4	5	6	7	2	3	4	5	6	7	2	3	4	5	6	7				
L1 (A)	75	.013	40	34	25	22	20	21	45	42	42	38	34	34	45	43	44	42	38	39	44	46	47	47	44	46				
	100	.021	40	34	25	22	20	21	46	43	43	39	36	35	46	45	45	43	39	39	46	49	50	48	45	47				
	200	.084	45	39	36	27	22	21	57	52	49	45	41	36	58	53	52	47	44	41	58	55	55	53	49	49				
	250	.180	54	48	45	38	32	25	64	59	56	49	46	40	64	59	58	52	48	44	64	61	60	57	53	51				
	350	.247	58	50	50	42	37	30	66	61	58	51	48	42	67	62	61	54	50	45	67	64	63	58	55	51				
L2 (A,B)	110	.007	44	39	30	26	23	21	47	42	44	41	34	34	47	43	47	46	39	38	46	49	51	51	46	45				
	200	.022	47	40	31	27	23	21	50	49	47	44	38	36	53	51	50	47	41	41	55	54	55	55	48	48				
	300	.044	49	41	38	30	24	21	58	53	50	47	43	39	59	55	53	51	46	43	61	58	57	57	51	50				
	400	.075	50	45	43	36	28	24	62	56	54	50	48	42	63	58	56	53	49	46	64	61	60	59	54	51				
	500	.119	53	50	48	42	35	29	66	60	58	53	51	46	67	62	60	56	54	49	69	63	63	61	57	54				
L3 (A,B,C)	140	.002	39	36	23	22	20	22	44	45	45	44	36	34	47	47	48	48	40	38	45	49	52	53	47	47				
	200	.004	41	36	25	22	20	22	48	48	47	47	37	35	50	50	51	51	42	41	51	52	54	56	49	48				
	400	.009	42	38	34	28	22	22	58	53	51	50	46	42	61	56	54	53	48	45	62	59	60	60	53	51				
	600	.023	50	46	43	40	31	27	64	59	56	54	52	47	64	61	59	57	54	50	68	64	64	63	59	56				
	700	.029	53	49	47	44	35	32	66	62	59	56	52	49	69	64	60	59	55	52	70	67	66	64	60	57				
L4 (B,C,D)	185	-.002	38	34	22	23	20	21	44	47	49	47	38	34	47	48	52	51	43	39	49	51	54	54	48	46				
	400	-.007	40	34	27	23	20	21	53	54	53	52	46	40	56	58	57	56	49	43	59	61	63	62	54	50				
	600	-.019	43	39	38	33	25	22	58	56	56	55	52	46	60	60	59	58	54	48	63	65	66	64	58	53				
	800	-.037	44	43	43	39	31	24	61	59	59	57	55	49	63	62	62	61	58	52	66	67	68	67	62	57				
	1000	-.062	50	49	49	45	38	31	65	63	62	60	58	52	66	64	64	63	61	55	69	69	69	68	66	60				
L5 (D)	185	-.001	43	36	25	25	21	21	47	48	50	47	37	35	47	49	52	50	42	39	48	52	55	55	48	47				
	400	-.004	41	36	28	25	21	21	54	52	51	49	43	39	56	56	56	54	46	43	59	58	62	60	52	50				
	600	-.006	45	41	38	32	25	22	58	57	54	53	49	44	61	58	58	56	51	47	63	62	64	62	56	53				
	800	-.011	46	45	44	38	32	25	62	60	58	55	53	47	65	62	60	59	55	50	66	66	65	64	59	55				
	1000	-.020	51	51	49	45	38	31	66	63	61	49	56	50	67	65	63	61	58	53	70	68	67	66	63	58				
L6 (D,E)	300	-.005	45	38	29	25	21	21	50	53	53	51	41	37	53	52	56	55	46	42	54	53	57	58	52	49				
	500	-.012	45	39	31	26	22	21	54	53	54	53	46	41	57	56	58	57	48	45	59	58	63	63	55	52				
	800	-.032	45	39	34	28	22	21	58	56	56	55	51	47	61	59	60	59	54	50	64	63	65	65	59	55				
	1200	-.073	46	45	43	38	31	25	61	59	58	58	56	51	64	62	62	61	59	55	69	67	68	68	64	60				
	1500	-.114	51	50	48	44	38	31	64	62	61	60	58	53	67	64	63	63	61	57	72	69	69	69	66	62				

- Notes:**
1. Base on tests conducted in accordance with ARI Standard 880-98.
 2. ΔPs is static pressure different from inlet to discharge.
 3. ΔPs is the minimum pressure required to deliver CFM shown with primary damper in wide open position.
 4. ΔPs does not include hot water or electric coils.



ARI Standard 880
A Participating Member
in the ARI 880
Certification Program

PERFORMANCE DATA – Intermittent Volume (Parallel Flow), Low Profile Design

RADIATED SOUND DATA (Fan off - 100% Primary Air)

Model AS_H

Unit (Fan) Size	CFM	ΔPs	Minimum ΔPs							1.0" ΔPs							1.5" ΔPs							3.0" ΔPs						
			Sound Power (db) Octave Band							Sound Power (db) Octave Band							Sound Power (db) Octave Band							Sound Power (db) Octave Band						
			2	3	4	5	6	7	2	3	4	5	6	7	2	3	4	5	6	7	2	3	4	5	6	7				
L1 (A)	75	.013	45	35	26	22	22	22	49	39	32	27	28	26	49	39	34	31	34	34	49	39	37	39	42	44				
	100	.021	45	35	28	24	22	22	50	40	34	28	29	26	51	41	35	33	34	34	51	43	38	39	42	44				
	200	.084	47	37	29	22	22	22	54	46	38	31	31	28	54	47	40	34	36	35	54	50	44	41	43	44				
	250	.180	50	43	35	26	25	22	59	51	43	35	33	31	60	52	45	37	37	36	61	55	49	42	44	45				
	350	.247	51	44	39	27	27	23	60	53	46	36	34	33	61	54	47	39	38	37	62	57	51	43	45	46				
L2 (A, B)	110	.007	45	35	26	22	22	22	48	38	34	28	29	29	48	38	38	34	35	36	48	39	41	40	44	46				
	200	.022	45	35	26	22	22	22	49	40	37	31	31	30	49	41	40	35	36	36	51	46	45	43	44	46				
	300	.044	47	37	29	24	23	22	53	44	40	35	33	31	56	47	42	38	37	37	57	51	48	44	44	46				
	400	.075	48	40	35	28	25	23	59	50	44	38	36	33	60	51	45	40	40	38	62	55	51	45	45	47				
	500	.119	50	41	40	33	29	24	62	53	47	39	39	35	63	54	49	42	42	40	63	56	53	47	46	47				
L3 (A, B, C)	140	.002	43	34	25	21	22	22	45	37	36	30	29	26	46	39	38	35	35	33	47	40	41	41	44	44				
	200	.004	45	34	27	23	22	22	46	40	38	32	30	27	48	43	41	37	36	34	49	47	44	43	44	45				
	400	.009	45	34	27	23	22	22	56	49	41	35	32	28	57	52	45	39	37	35	59	56	51	46	45	45				
	600	.023	47	38	34	27	28	23	61	52	45	39	37	31	63	56	48	43	40	37	65	60	54	48	46	46				
	700	.029	47	39	37	32	32	24	62	54	47	41	38	33	65	57	50	44	42	39	67	61	55	49	47	46				
L4 (B, C, D)	185	-.002	42	35	24	21	21	22	45	41	38	33	29	26	46	41	39	36	34	31	48	44	42	41	43	44				
	400	-.007	42	34	24	21	21	22	53	48	42	37	32	28	54	51	46	41	36	32	58	55	52	48	45	45				
	600	-.019	43	35	30	26	26	27	56	49	45	42	35	31	59	53	49	45	39	34	62	60	55	51	46	46				
	800	-.037	46	38	35	27	30	25	60	52	48	46	38	33	63	55	51	50	42	37	65	61	57	54	48	46				
	1000	-.062	49	41	39	34	35	27	64	55	51	49	42	35	66	58	54	52	45	40	69	64	59	56	50	47				
L5 (D)	185	-.001	43	32	24	21	20	22	48	38	39	33	27	26	48	39	41	36	33	31	48	45	45	42	41	44				
	400	-.004	43	33	25	21	20	22	52	43	41	35	29	28	55	48	45	39	34	33	57	54	52	46	43	44				
	600	-.006	44	33	29	24	22	22	57	46	43	37	32	30	60	50	47	41	36	35	61	57	54	48	44	45				
	800	-.011	46	37	35	28	29	23	60	49	47	40	36	33	63	52	49	43	39	37	66	60	56	49	45	45				
	1000	-.020	49	39	40	34	35	27	63	52	49	43	40	36	66	55	52	46	42	40	69	62	57	51	47	46				
L6 (D, E)	300	-.001	44	34	26	22	22	22	48	42	42	37	31	28	48	40	45	40	37	34	49	45	46	45	45	44				
	500	-.004	46	34	26	22	22	22	52	45	44	38	33	29	53	48	48	43	38	35	57	51	52	49	46	44				
	800	-.006	46	36	31	25	23	22	58	50	48	41	36	33	60	52	51	45	40	38	62	57	55	51	47	45				
	1200	-.011	46	37	37	33	30	24	61	54	52	45	39	36	65	57	55	49	43	41	69	63	61	55	50	48				
	1500	-.020	48	40	42	38	36	29	64	56	54	47	43	39	68	59	57	51	46	42	72	66	62	57	52	49				

FAN POWERED UNITS

- Notes:**
1. Base on tests conducted in accordance with ARI Standard 880-98.
 2. ΔPs is static pressure different from inlet to discharge.
 3. ΔPs is the minimum pressure required to deliver CFM shown with primary damper in wide open position.
 4. ΔPs does not include hot water or electric coils.



ARI Standard 880
A Participating Member
in the ARI 880
Certification Program

MODEL NUMBERING – Intermittent Volume (Parallel Flow), Low Profile Design

FAN POWERED UNITS

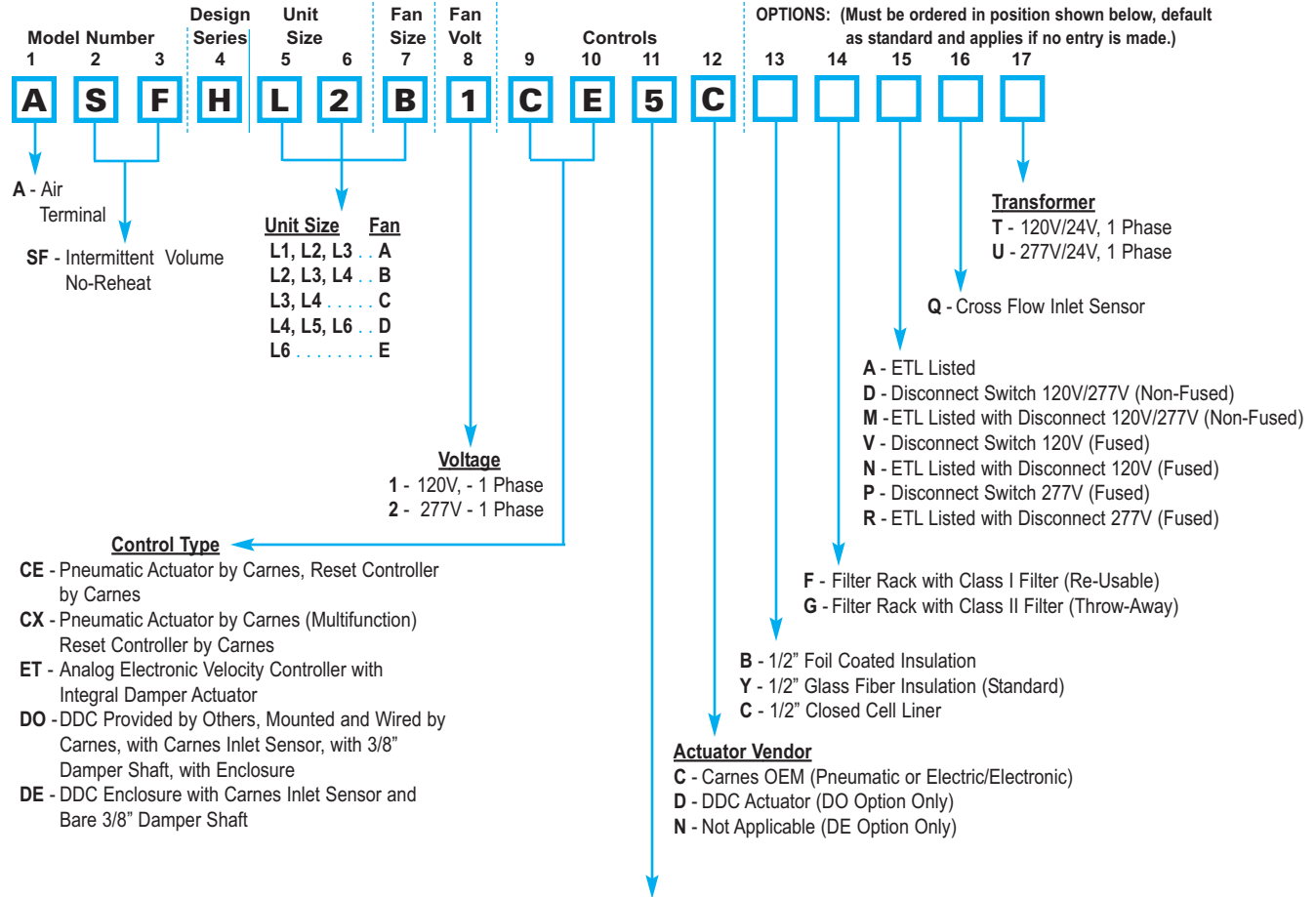

NOTE: Hand of controls is determined by facing the averaging flow sensor (inlet of the unit) with the supply air hitting the back of your head.

Controls and Damper Arrangement

- *1 - Normally Open - Right Hand Controls (Electronic/DO, DE & ET) (All Pneumatic Control Types for Reverse Acting Thermostat)
- *2 - Normally Open - Left Hand Controls (Electronic/DO, DE & ET) (All Pneumatic Control Types for Reverse Acting Thermostat)
- 3 - Normally Closed - Right Hand Controls (All Pneumatic Control Types for Direct Acting Thermostat)
- 4 - Normally Closed - Left Hand Controls (All Pneumatic Control Types for Direct Acting Thermostat)
- 5 - Normally Open - Right Hand Controls (All Pneumatic Control Types for Direct Acting Thermostat)
- 6 - Normally Open - Left Hand Controls (All Pneumatic Control Types for Direct Acting Thermostat)
- 7 - Normally Closed - Right Hand Controls (All Pneumatic Control Types for Reverse Acting Thermostat)
- 8 - Normally Closed - Left Hand Controls (All Pneumatic Control Types for Reverse Acting Thermostat)

Electronic Thermostat

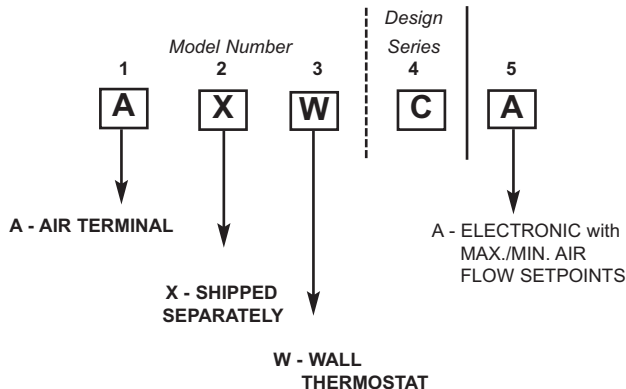

*Electronic and DDC Units DO NOT Fail Open, "1" or "2" is used for Right or Left Hand Only. Electronic Units are shipped with the Damper in Open Position.

A Carnes Electronic Thermostat **must be ordered** with the Electronic ET Control Option.

DIMENSIONAL DATA – Intermittent Volume (Parallel Flow), Low Profile Design

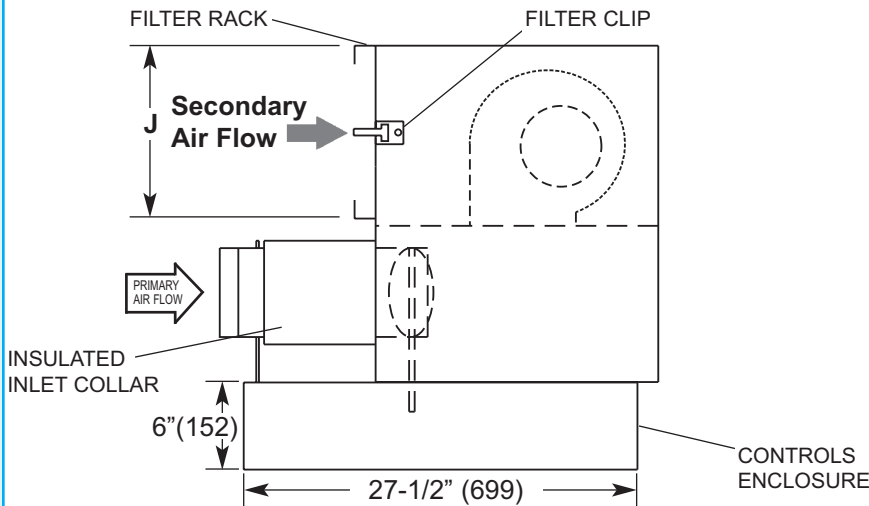

**RIGHT HAND UNIT SHOWN
LEFT HAND AVAILABLE**

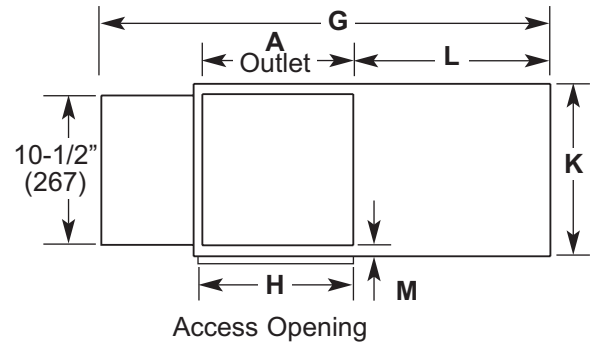
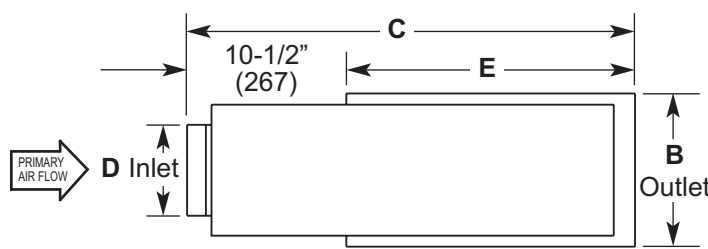

DIMENSIONS LISTED IN INCHES (MILLIMETERS)

Fan Size	Inlet Size	Unit Size	Primary Nominal CFM (L/s)	Secondary Nominal CFM (L/s) @.25"E.S.P.	Fan H.P.	Outlet		C	Inlet D	E	G	H	J	K	L	M
						A	B									
A	05	L1	350 (165)	300 (142)	1/6	12 (305)	9-1/2 (241)	35-1/4 (895)	4-7/8 (124)	24-3/4 (629)	35-1/2 (902)	12-1/2 (318)	14 (356)	10-1/2 (267)	17 (432)	1/2 (13)
	06	L2	500 (236)						5-7/8 (149)							
	07	L3	700 (330)						6-7/8 (175)							
B	06	L2	500 (236)	430 (203)	1/6	12 (305)	9-1/2 (241)	35-1/4 (895)	5-7/8 (149)	24-3/4 (629)	35-1/2 (902)	12-1/2 (318)	14 (356)	10-1/2 (267)	17 (432)	1/2 (13)
	07	L3	700 (330)						6-7/8 (175)							
	08	L4	1000 (472)						7-7/8 (200)							
C	07	L3	700 (330)	660 (312)	1/6	12 (305)	9-1/2 (241)	37-1/4 (946)	6-7/8 (175)	26-3/4 (679)	39-1/2 (1003)	14-1/2 (368)	13-1/2 (343)	12-1/2 (318)	19 (483)	1/2 (13)
	08	L4	1000 (472)						7-7/8 (200)							
D	08	L4	1000 (472)	985(465)	1/4	12 (305)	9-1/2 (241)	37-1/4 (946)	7-7/8 (200)	26-3/4 (679)	37-1/2 (953)	12-1/2 (318)	14 (356)	10-1/2 (267)	19 (483)	1/2 (13)
D	08	L5	1000 (472)	1000 (472)	1/4	12 (305)	9-1/2 (241)	37-1/4 (946)	7-7/8 (200)	26-3/4 (679)	39-1/2 (1003)	14-1/2 (368)	13-1/2 (343)	12-1/2 (318)	19 (483)	1/2 (13)
	10	L6	1500 (708)						9-7/8 (251)							
E	10	L6	1500 (708)	1460 (689)	1/2	14 (356)	11-1/2 (292)	37-1/4 (946)	9-7/8 (251)	26-3/4 (679)	39-1/2 (1003)	14-1/2 (368)	18 (457)	12-1/2 (318)	19 (483)	1/2 (13)

Note: Outlet dimensions refer to the actual opening.

MODEL NUMBERING – Intermittent Volume (Parallel Flow), Low Profile Design

FAN POWERED UNITS

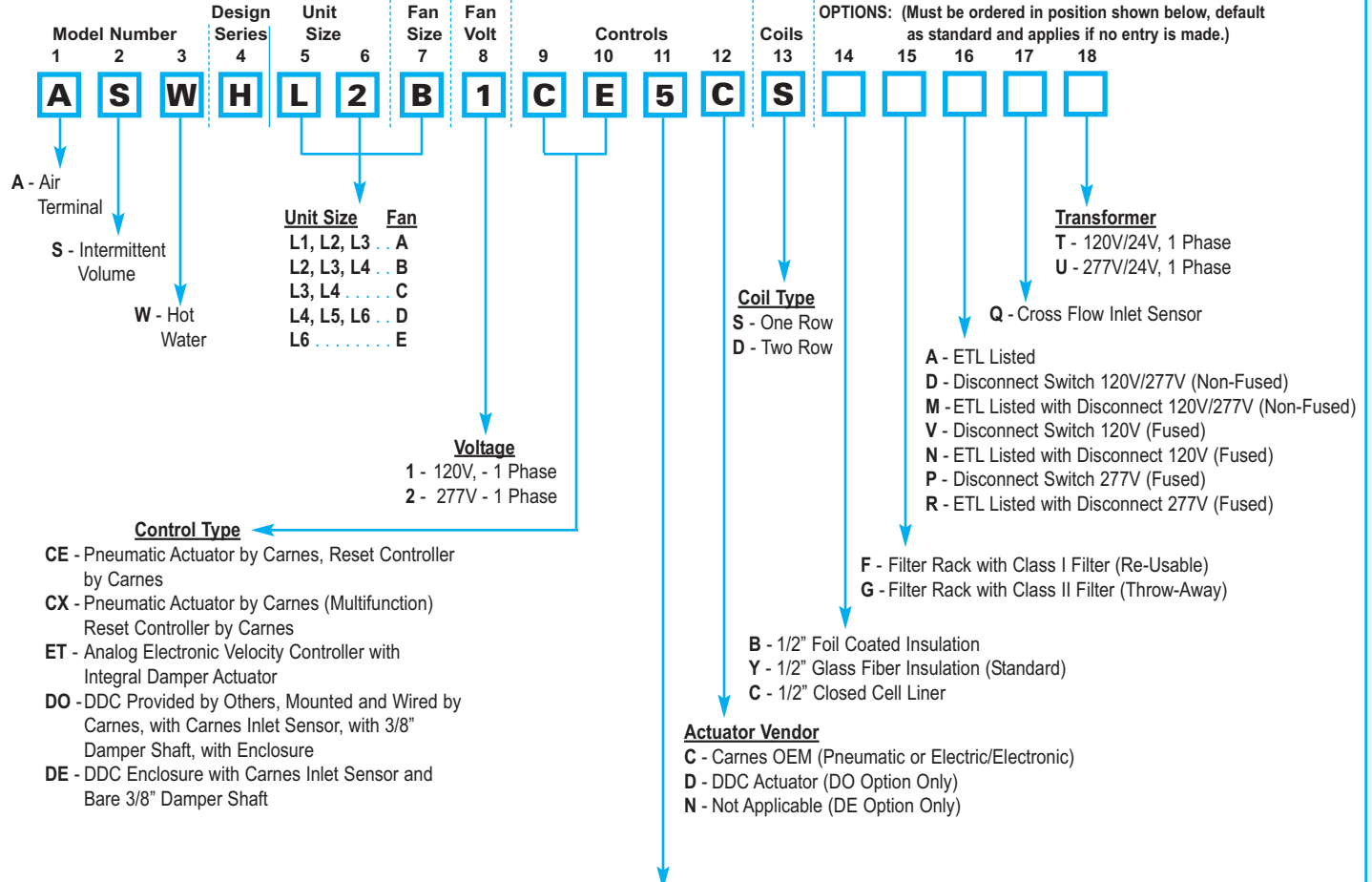

Controls and Damper Arrangement

NOTE: Hand of controls is determined by facing the averaging flow sensor (inlet of the unit) with the supply air hitting the back of your head.

- *1 - Normally Open - Right Hand Controls (Electronic/DO, DE & ET) (All Pneumatic Control Types for Reverse Acting Thermostat)
- *2 - Normally Open - Left Hand Controls (Electronic/DO, DE & ET) (All Pneumatic Control Types for Reverse Acting Thermostat)
- 3 - Normally Closed - Right Hand Controls (All Pneumatic Control Types for Direct Acting Thermostat)
- 4 - Normally Closed - Left Hand Controls (All Pneumatic Control Types for Direct Acting Thermostat)
- 5 - Normally Open - Right Hand Controls (All Pneumatic Control Types for Direct Acting Thermostat)
- 6 - Normally Open - Left Hand Controls (All Pneumatic Control Types for Direct Acting Thermostat)
- 7 - Normally Closed - Right Hand Controls (All Pneumatic Control Types for Reverse Acting Thermostat)
- 8 - Normally Closed - Left Hand Controls (All Pneumatic Control Types for Reverse Acting Thermostat)

Electronic Thermostat

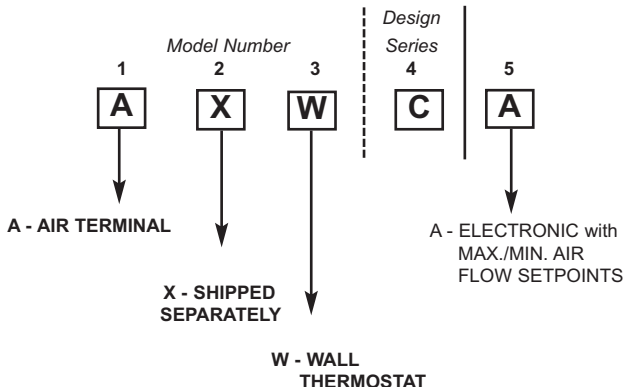

*Electronic and DDC Units DO NOT Fail Open, "1" or "2" is used for Right or Left Hand Only. Electronic Units are shipped with the Damper in Open Position.

A Carnes Electronic Thermostat **must be ordered** with the Electronic ET Control Option.

DIMENSIONAL DATA – Intermittent Volume (Parallel Flow), Low Profile Design

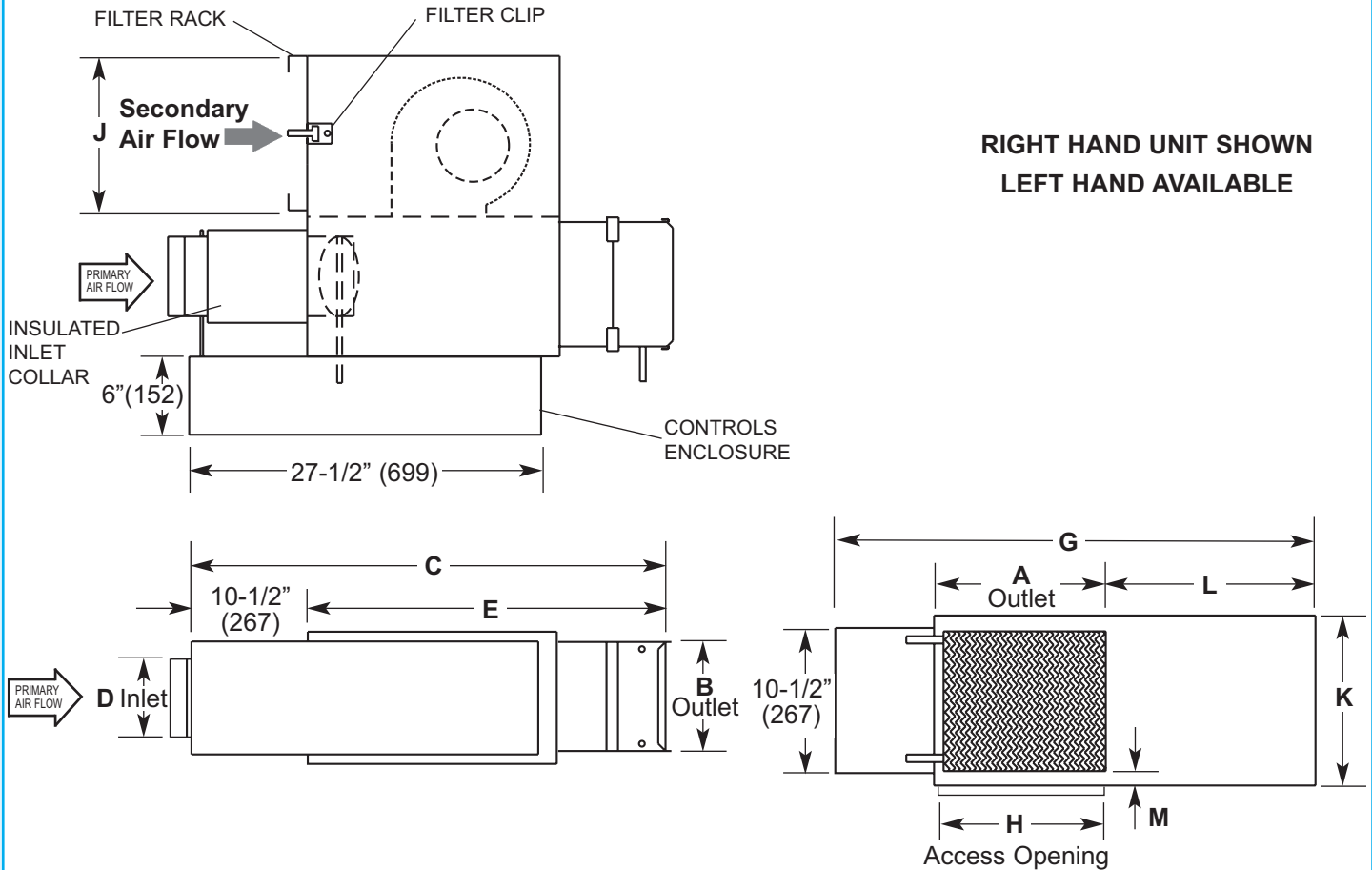

DIMENSIONS LISTED IN INCHES (MILLIMETERS)																			
Fan Size	Inlet Size	Unit Size	Primary Nominal CFM(L/s)	Secondary Nominal CFM (L/s) @.25"E.S.P.	Fan H.P.	Outlet		C 1-Row	C 2-Row	Inlet		E 1-Row	E 2-Row	G	H	J	K	L	M
						A	B			D									
A	05	L1	350 (165)	300 (142)	1/6	12 (305)	10 (254)	41-3/8 (1051)	42-3/4 (1086)	4-7/8 (124)	30-7/8 (784)	32-1/4 (819)	35-1/2 (902)	12-1/2 (318)	14 (356)	10-1/2 (267)	17 (432)	1/2 (13)	
	06	L2	500 (236)							5-7/8 (149)									
	07	L3	700 (330)							6-7/8 (175)									
B	06	L2	500 (236)	430 (203)	1/6	12 (305)	10 (254)	41-3/8 (1051)	42-3/4 (1086)	5-7/8 (149)	30-7/8 (784)	32-1/4 (819)	35-1/2 (902)	12-1/2 (318)	14 (356)	10-1/2 (267)	17 (432)	1/2 (13)	
	07	L3	700 (330)							6-7/8 (175)									
	08	L4	1000 (472)							7-7/8 (200)									
C	07	L3	700 (330)	660 (312)	1/6	12 (305)	10 (254)	41-3/8 (1051)	42-3/4 (1086)	6-7/8 (175)	30-7/8 (784)	32-1/4 (819)	35-1/2 (902)	12-1/2 (318)	14 (356)	10-1/2 (267)	19 (483)	1/2 (13)	
	08	L4	1000 (472)							7-7/8 (200)									
D	08	L4	1000 (472)	985 (465)	1/4	12 (305)	10 (254)	43-3/8 (1102)	44-3/4 (1137)	7-7/8 (200)	32-7/8 (835)	34-1/4 (870)	37-1/2 (953)	12-1/2 (318)	14 (356)	10-1/2 (267)	19 (483)	1/2 (13)	
D	08	L5	1000 (472)	1000 (472)	1/4	14 (356)	12-1/2 (318)	43-3/8 (1102)	44-3/4 (1137)	7-7/8 (200)	32-7/8 (835)	34-1/4 (870)	39-1/2 (1003)	14-1/2 (368)	13-1/2 (343)	12-1/2 (318)	19 (483)	--	
	10	L6	1500 (708)							9-7/8 (251)					18(457)				
E	10	L6	1500 (708)	1460 (689)	1/2	14 (356)	12-1/2 (318)	43-3/8 (1102)	44-3/4 (1137)	9-7/8 (251)	32-7/8 (835)	34-1/4 (870)	39-1/2 (1003)	14-1/2 (368)	18(457)	12-1/2 (318)	19 (483)	--	

Note: Outlet is designed for slip and drive duct connection.

MODEL NUMBERING – Intermittent Volume (Parallel Flow), Low Profile Design

FAN POWERED UNITS

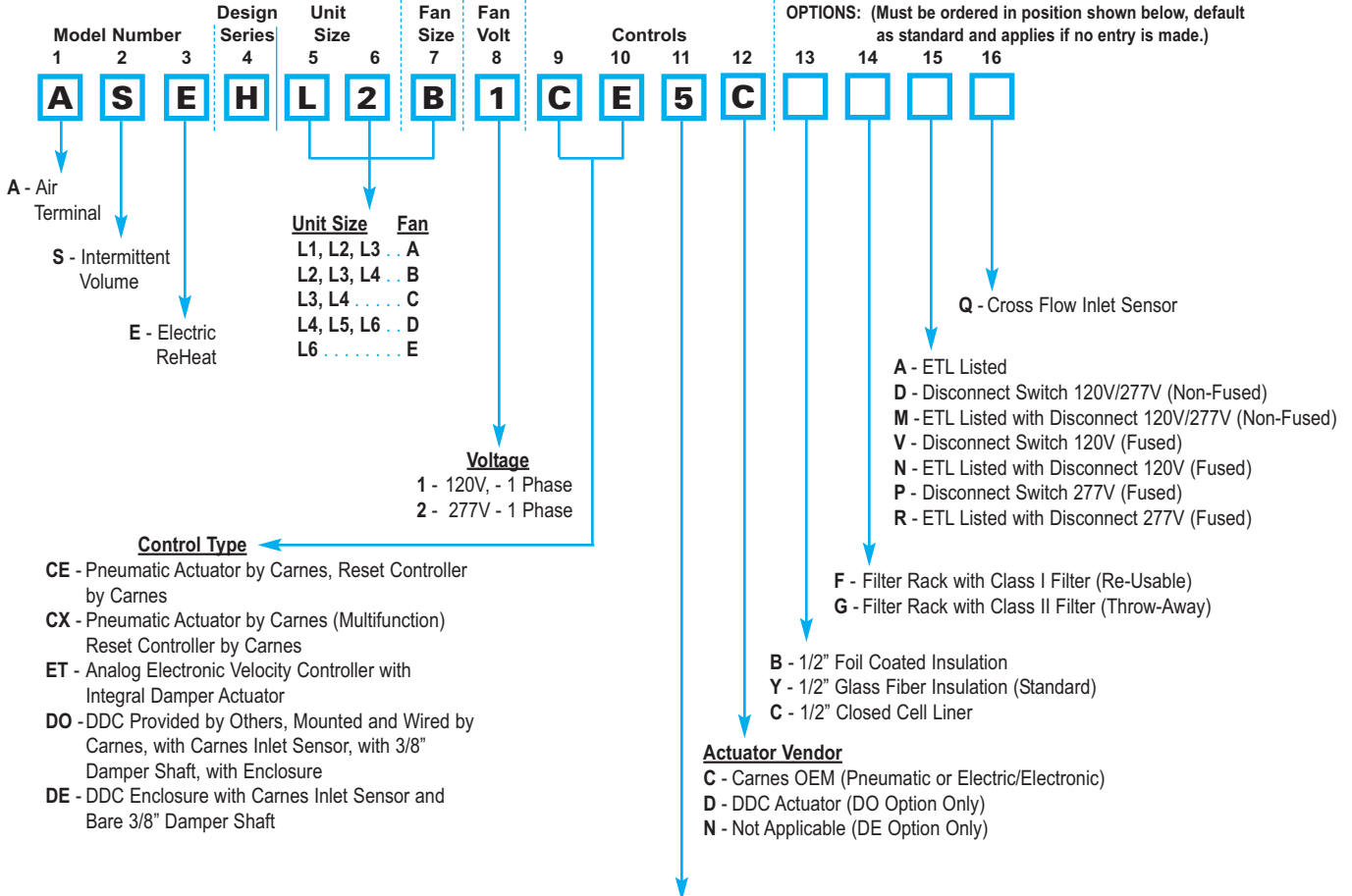

Controls and Damper Arrangement

NOTE: Hand of controls is determined by facing the averaging flow sensor (inlet of the unit) with the supply air hitting the back of your head.

- *1 - Normally Open - Right Hand Controls (Electronic/DO, DE & ET) (All Pneumatic Control Types for Reverse Acting Thermostat)
- *2 - Normally Open - Left Hand Controls (Electronic/DO, DE & ET) (All Pneumatic Control Types for Reverse Acting Thermostat)
- 3 - Normally Closed - Right Hand Controls (All Pneumatic Control Types for Direct Acting Thermostat)
- 4 - Normally Closed - Left Hand Controls (All Pneumatic Control Types for Direct Acting Thermostat)
- 5 - Normally Open - Right Hand Controls (All Pneumatic Control Types for Direct Acting Thermostat)
- 6 - Normally Open - Left Hand Controls (All Pneumatic Control Types for Direct Acting Thermostat)
- 7 - Normally Closed - Right Hand Controls (All Pneumatic Control Types for Reverse Acting Thermostat)
- 8 - Normally Closed - Left Hand Controls (All Pneumatic Control Types for Reverse Acting Thermostat)

Electronic Thermostat

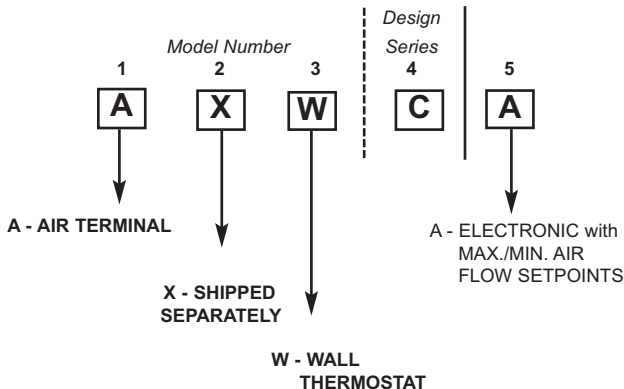

*Electronic and DDC Units DO NOT Fail Open, "1" or "2" is used for Right or Left Hand Only. Electronic Units are shipped with the Damper in Open Position.

A Carnes Electronic Thermostat **must be ordered** with the Electronic ET Control Option.

Power Transformers are included with the Electric Heater

DIMENSIONAL DATA – Intermittent Volume (Parallel Flow), Low Profile Design

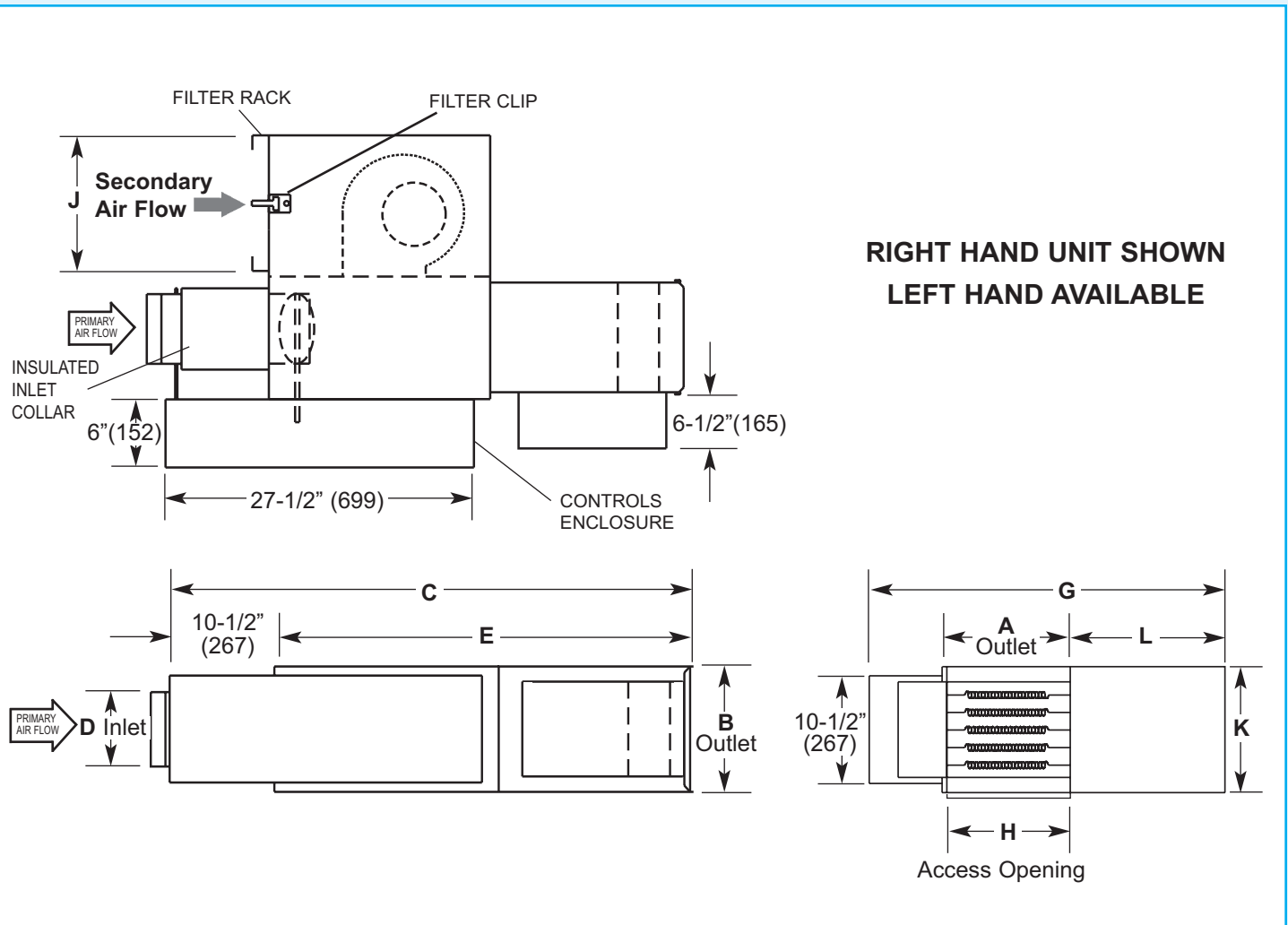

**RIGHT HAND UNIT SHOWN
LEFT HAND AVAILABLE**

FAN POWERED UNITS

DIMENSIONS LISTED IN INCHES (MILLIMETERS)

Fan Size	Inlet Size	Unit Size	Primary Nominal CFM(L/s)	Secondary Nominal CFM (L/s) @ 25"E.S.P.	Fan H.P.	Outlet		C	Inlet D	E	G	H	J	K	L
						A	B								
A	05	L1	350 (165)	300 (142)	1/6	12 (305)	10-1/2 (267)	57-1/2 (1461)	4-7/8 (124)	47 (1194)	35-1/2 (902)	12-1/2 (318)	14 (356)	10-1/2 (267)	17 (432)
	06	L2	500 (236)						5-7/8 (149)						
	07	L3	700 (330)						6-7/8 (175)						
B	06	L2	500 (236)	430 (203)	1/6	12 (305)	10-1/2 (267)	57-1/2 (1461)	5-7/8 (149)	47 (1194)	35-1/2 (902)	12-1/2 (318)	14 (356)	10-1/2 (267)	17 (432)
	07	L3	700 (330)						6-7/8 (175)						
	08	L4	1000 (472)						7-7/8 (200)						
C	07	L3	700 (330)	660 (312)	1/6	12 (305)	10-1/2 (267)	59-1/2 (1511)	6-7/8 (175)	49 (1245)	37-1/2 (953)	12-1/2 (318)	14 (356)	10-1/2 (267)	19 (483)
	08	L4	1000 (472)						7-7/8 (200)						
D	08	L4	1000 (472)	985 (465)	1/4	12 (305)	10-1/2 (267)	59-1/2 (1511)	7-7/8 (200)	49 (1245)	37-1/2 (953)	12-1/2 (318)	14 (356)	10-1/2 (267)	19 (483)
D	08	L5	1000 (472)	1000 (472)	1/4	14 (356)	12-1/2 (318)	59-1/2 (1511)	7-7/8 (200)	49 (1245)	39-1/2 (1003)	14-1/2 (368)	13-1/2 (343)	12-1/2 (318)	19 (483)
	10	L6	1500 (708)						9-7/8 (251)				18 (457)		
E	10	L6	1500 (708)	1460 (689)	1/2	14 (356)	12-1/2 (318)	59-1/2 (1511)	9-7/8 (251)	49 (1245)	39-1/2 (1003)	14-1/2 (368)	13-1/2 (343)	12-1/2 (318)	19 (483)

Note: Outlet is designed for slip and drive duct connection.

FAN TERMINAL UNITS – Constant Volume (Series Flow), Low Profile Design

Models **ACF w/o Reheat**
 ACW w/ Hot Water Reheat
 ACE w/ Electric Reheat

The **Carnes** low profile constant volume fan terminal unit provides constant air volume to the space while retaining the advantages of a variable air volume system.

The primary air control assembly operates in the same manner as a standard throttling control valve when cooling loads are high. As cooling loads diminish the integral blower(s) induces warm ceiling plenum air to maintain constant air volume.

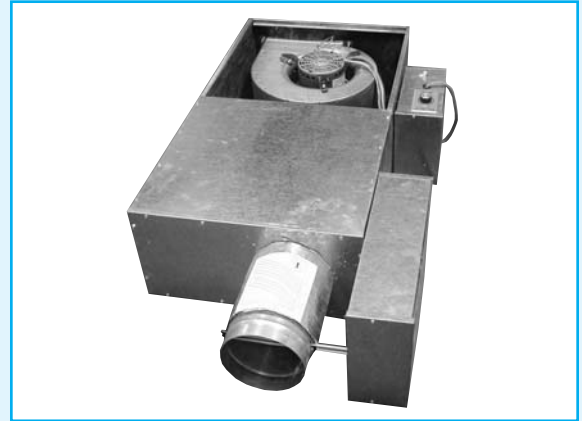

Features Include:

- Air flow capacities to 1525 CFM.
- Durable 22 gauge galvanized steel casing construction.
- Access panel for internal components.
- Standard inlet sizes and flange or slip and drive discharge connections.
- Forward curved centrifugal type fan assemblies with 120 or 277 volt, single phase, fractional horsepower PSC motors.
- Low leakage primary air damper design.
- Secondary air filter rack.
- Performance data based on tests conducted in accordance with ARI Standard 880-98.
- Pressure independent pneumatic or electronic controls available.
- Field adjustable P/E switch with pneumatic controls.
- Averaging type velocity sensor and calibration chart for measuring air flow through the primary air damper.
- Insulation is 1/2" thick, 2.0lb. dual density fiberglass with surface treated to prevent air erosion, UL listed and meets NFPA 90A requirements.
- Optional primary air controls enclosure.
- Optional one or two row hot water coils (Model ACW). Coil is factory attached to the unit discharge.
- Optional electric reheat coils (Model ACE). Coil is factory attached to unit discharge or shipped separately for field mounting.
- Optional secondary air filters, Class I (re-usable) or Class II (throw away).
- Optional foil coated insulation (Hospital, Laboratory, etc. applications).
- Optional ETL listing.

Available Modules:

- Basic control unit — **Model ACF.**
- Basic control unit with hot water coil — **Model ACW.**
- Basic control unit with electric coil — **Model ACE.**

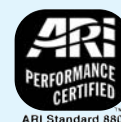

FAN CURVES CFM vs EXTERNAL STATIC PRESSURE

FAN SIZE A - AC L1
1/6 H.P. Motor

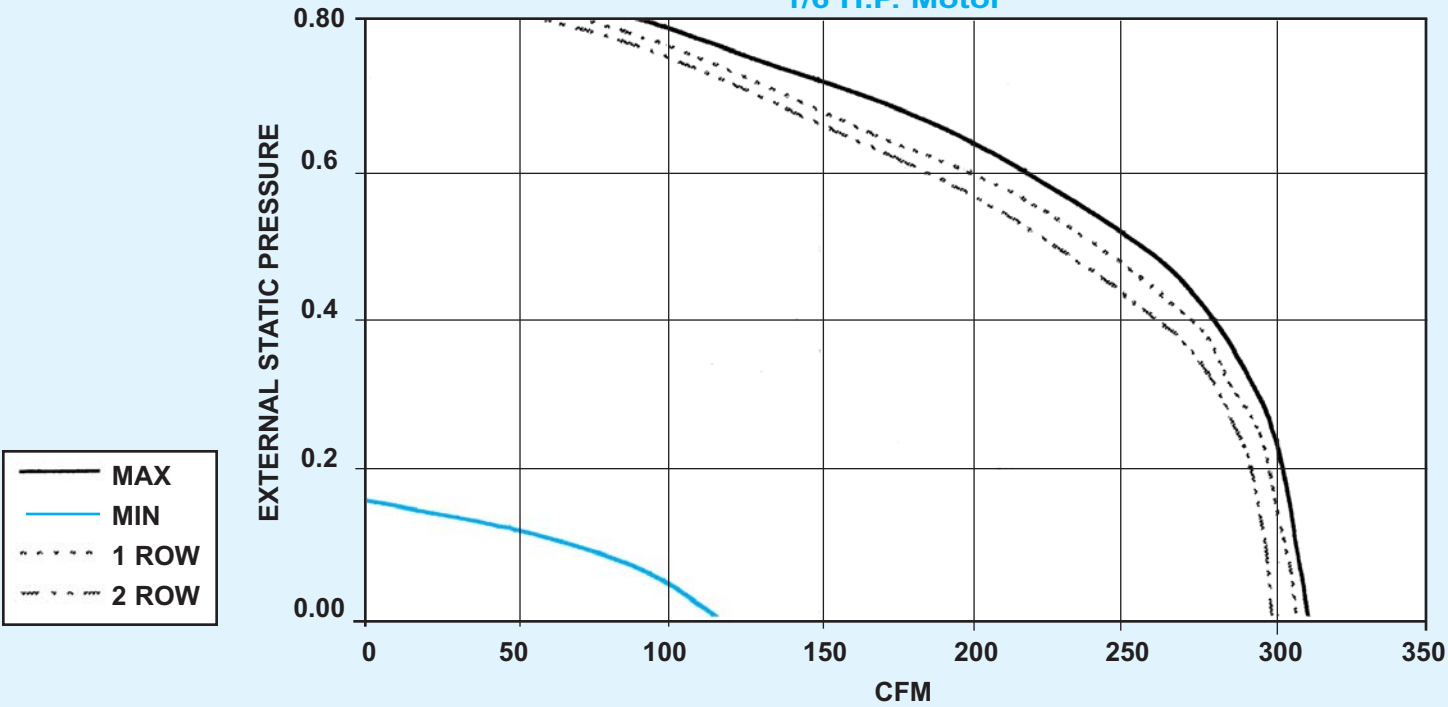

FAN SIZE B - AC L2
1/6 H.P. Motor

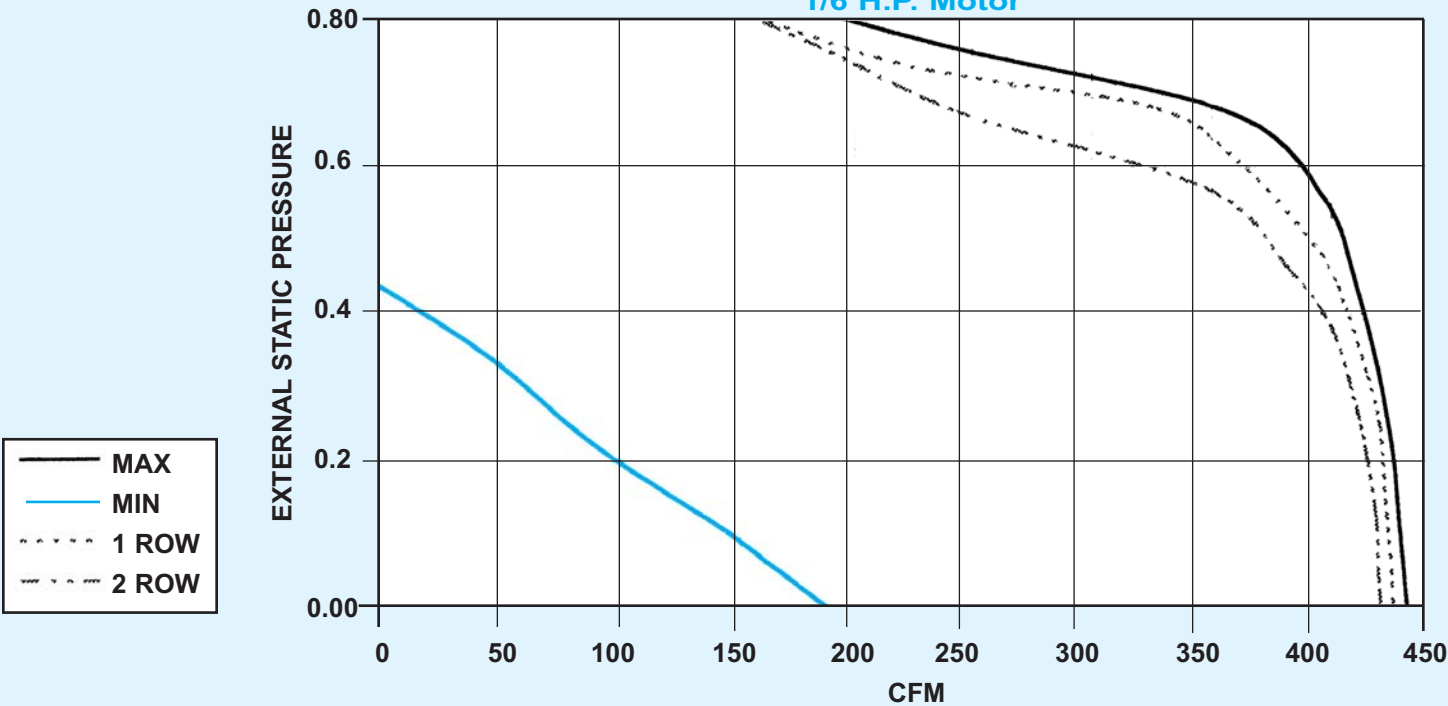

- NOTES:**
1. External static pressure (ESP) consists of down stream duct work, coils, flex duct, etc.
 2. Pressure drop due to heating coils are treated as external static pressure
 3. For proper operation, the downstream ESP must be at least 0.20" W.G.

FAN POWERED UNITS

FAN CURVES CFM vs EXTERNAL STATIC PRESSURE

FAN POWERED UNITS

FAN SIZE C - AC L3
1/6 H.P. Motor

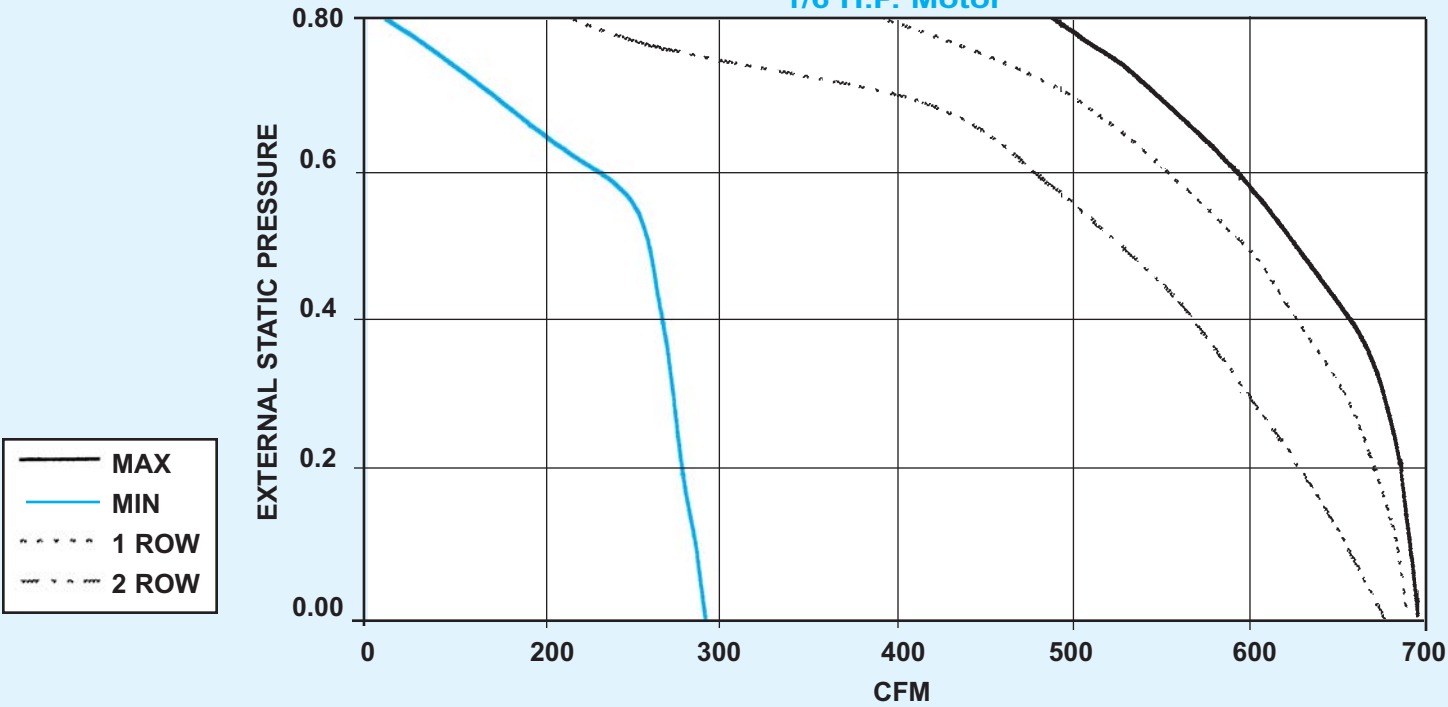

FAN SIZE D - AC L4
1/4 H.P. Motor

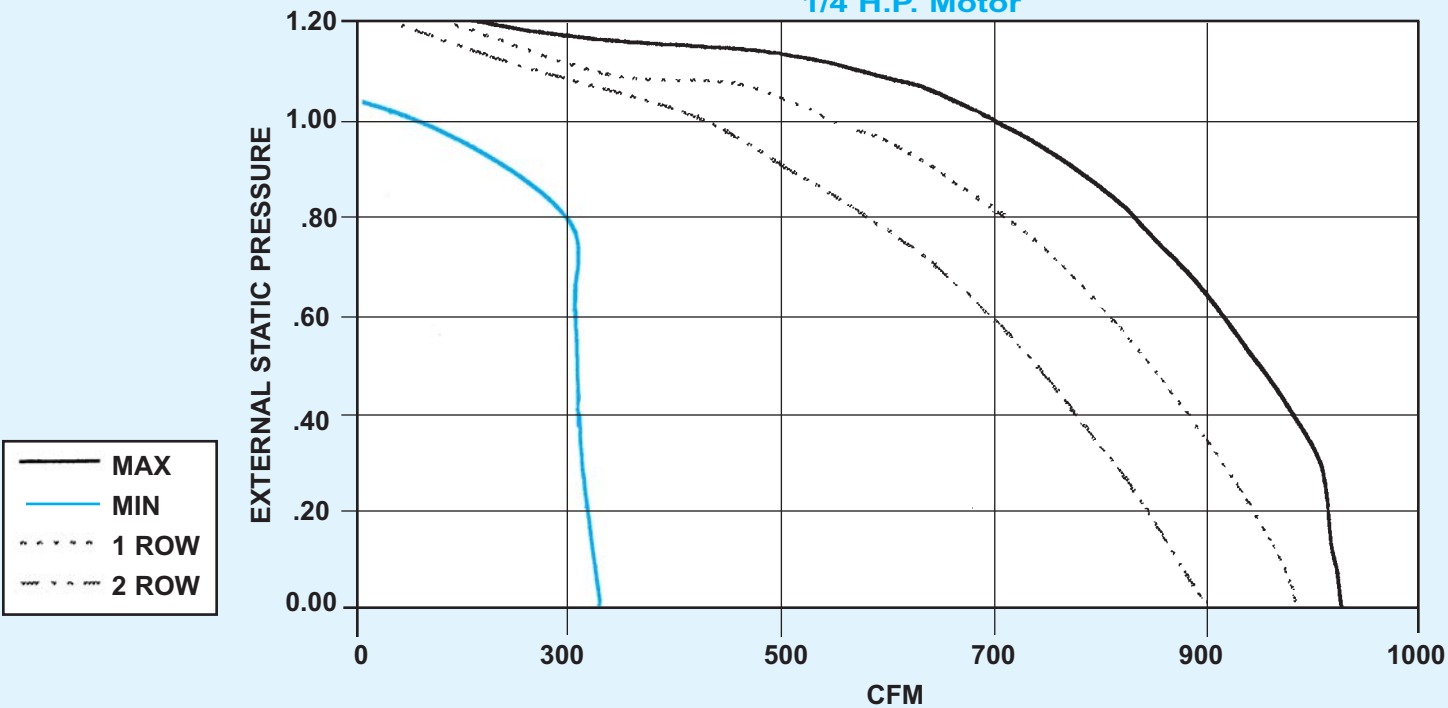

- NOTES:**
1. External static pressure (ESP) consists of down stream duct work, coils, flex duct, etc.
 2. Pressure drop due to heating coils are treated as external static pressure
 3. For proper operation, the downstream ESP must be at least 0.20" W.G.

FAN CURVES CFM vs EXTERNAL STATIC PRESSURE

FAN SIZE E - AC L5
1/4 H.P. Motor

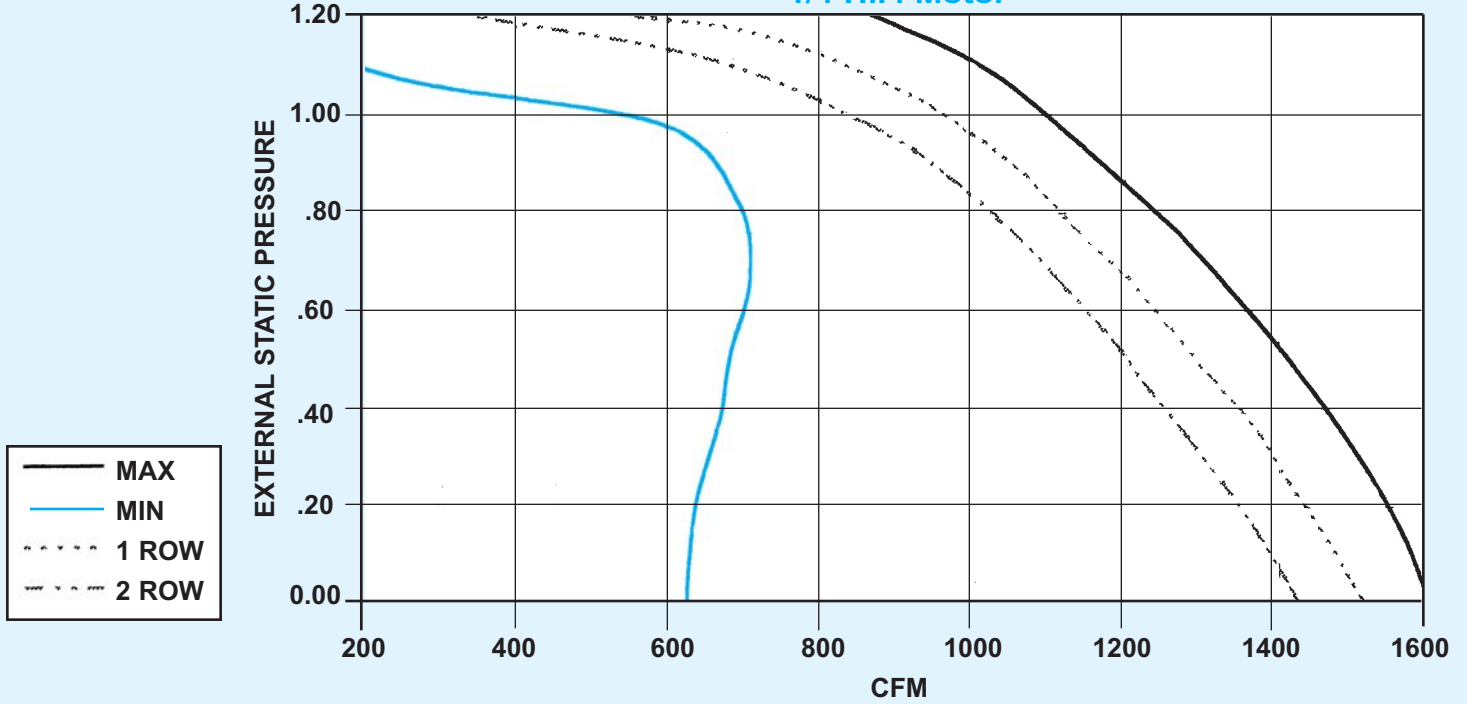

FAN POWERED UNITS

- NOTES:
1. External static pressure (ESP) consists of down stream duct work, coils, flex duct, etc.
 2. Pressure drop due to heating coils are treated as external static pressure
 3. For proper operation, the downstream ESP must be at least 0.20" W.G.

PERFORMANCE DATA – Constant Volume (Series Flow), Low Profile Design

**UNIT SIZE - L1
Inlet Size - 5"**

(FAN ON — 100% Primary Air/Mix/100% Secondary Air)

FAN POWERED UNITS

Primary/ Secondary CFM	Primary Air ΔP_s	Discharge Sound							Max. NC	Radiated Sound							Max. NC
		Sound Power db Octave Band								Sound Power db Octave Band							
		2	3	4	5	6	7	2		3	4	5	6	7			
290/0	.29	57	54	54	51	45	39	11	58	54	50	45	36	29	19		
	.50	61	55	56	54	47	40	15	60	54	52	49	39	30	21		
	1.00	60	56	58	56	49	41	14	60	56	55	51	42	35	24		
	1.50	62	57	59	57	50	41	17	63	57	57	52	46	40	26		
150/150	3.00	64	59	60	59	51	43	19	63	58	59	51	49	45	28		
	.50	53	50	52	50	43	36	-	54	47	45	43	35	24	14		
	1.00	53	50	52	50	44	37	-	54	48	47	44	39	34	15		
	1.50	53	51	53	51	45	38	-	54	50	48	46	42	40	17		
0/290	3.00	54	52	54	52	46	39	-	55	51	51	49	48	48	23		
	—	51	48	52	50	42	35	-	53	45	44	44	32	21	15		
	.07	47	43	44	40	31	22	-	52	45	41	38	27	20	—		
	.50	51	46	48	43	33	23	-	52	46	43	41	32	24	12		
150/0	1.00	51	47	49	44	34	24	-	52	47	46	43	39	34	14		
	1.50	52	48	50	45	35	24	-	53	48	47	45	42	39	16		
	3.00	53	50	52	48	37	29	-	53	49	50	49	48	48	23		
	.50	45	42	43	39	29	21	-	51	44	41	39	31	24	10		
75/75	1.00	47	43	44	39	30	22	-	51	44	43	41	36	34	12		
	1.50	47	44	45	40	31	22	-	52	45	44	42	40	41	16		
	3.00	48	45	47	42	34	27	-	52	45	45	45	46	48	23		
	—	42	42	45	39	27	21	-	53	45	41	38	27	20	—		
0/150	.02	42	39	40	33	22	20	-	48	39	35	31	19	20	—		
	.50	44	41	41	35	23	20	-	48	41	39	35	29	23	—		
	1.00	44	42	42	37	26	20	-	49	42	41	39	36	34	10		
	1.50	45	43	43	38	27	21	-	49	42	42	40	40	40	15		
	3.00	47	45	46	41	32	24	-	49	43	45	44	46	49	24		
38/38	.50	42	39	40	34	22	20	-	49	41	39	34	28	22	—		
	1.00	42	40	41	35	24	20	-	48	40	39	37	36	36	11		
	1.50	42	41	42	36	26	21	-	49	40	39	38	39	42	17		
	3.00	42	41	42	36	27	24	-	49	41	40	41	43	43	18		
0/75	—	41	40	42	34	22	20	-	48	39	35	31	19	20	—		

- NOTES:**
1. ΔP_s static pressure difference from inlet to discharge.
 2. ΔP_s is the minimum required to deliver CFM shown in the primary damper in open position.
 3. ΔP_s does not include hot water or electric coils.
 4. Dash (-) indicates NC level less than 10.

NC levels are derived from tests conducted in accordance with ARI Standard 880-98 and are calculated in accordance with Appendix E of ARI Standard 885-98 as application data based on the following:

Discharge NC levels are based on -

- a) 5 foot rectangular duct lined with 1" fiberglass insulation.
- b) 6 foot lined flex duct (8" diameter).
- c) Maximum of 300 CFM per outlet.
- d) Space effect factor (5000 ft³) at 10 feet from outlet.
- e) End reflection.
- f) Environment adjustment factor.

Radiated NC levels are based on -

- a) Plenum/ceiling effect - 5/8" mineral fiber tile, 35 lb/ft³ - 3 foot plenum
- b) Space effect factor (5000 ft³) at 10 feet from source.
- c) Environment adjustment factor.



ARI Standard 880
A Participating Member
in the ARI 880
Certification Program



PERFORMANCE DATA – Constant Volume (Series Flow), Low Profile Design

**UNIT SIZE - L2
Inlet Size - 6"**

(FAN ON — 100% Primary Air/Mix/100% Secondary Air)

Primary/ Secondary CFM	Primary Air ΔP_s	Discharge Sound							Radiated Sound								
		Sound Power db Octave Band							Max. NC	Sound Power db Octave Band							Max. NC
		2	3	4	5	6	7	2		3	4	5	6	7			
420/0	.23	59	58	58	56	53	48	15	61	56	53	49	39	29	22		
	.50	60	58	59	59	55	49	15	61	56	55	55	42	32	26		
	1.00	61	58	60	59	55	49	15	61	58	57	56	44	37	27		
	1.50	62	59	60	59	56	49	16	63	59	59	57	47	42	28		
	3.00	64	61	61	60	57	50	18	64	60	60	60	52	49	32		
210/210	.50	57	55	57	56	53	48	12	57	51	50	49	39	29	20		
	1.00	57	55	57	56	53	48	12	57	52	51	50	41	35	21		
	1.50	57	56	57	57	54	49	14	58	53	52	50	44	41	21		
	3.00	58	57	58	57	54	49	15	58	54	56	54	50	49	25		
0/420	—	54	54	56	55	52	47	11	56	49	49	48	38	26	19		
300/0	.12	51	50	51	47	41	35	—	53	48	45	42	30	20	13		
	.50	54	52	55	52	44	36	—	55	50	49	48	35	27	19		
	1.00	55	53	55	52	45	36	10	56	52	52	51	40	35	22		
	1.50	55	54	55	53	45	37	11	57	53	54	52	43	41	23		
	3.00	58	56	58	56	49	39	14	59	56	58	56	50	49	27		
150/150	.50	50	48	50	47	41	33	—	51	46	45	43	32	24	14		
	1.00	50	48	51	48	41	34	—	52	47	47	45	37	35	16		
	1.50	51	49	52	49	42	34	—	53	48	49	46	41	39	18		
	3.00	52	50	53	50	42	34	—	53	50	52	50	48	48	23		
0/300	—	48	46	49	46	40	32	—	52	45	44	43	31	20	14		
200/0	.05	47	46	47	43	36	29	—	51	45	42	40	28	20	11		
	.50	49	48	52	47	38	30	—	51	46	45	45	32	24	16		
	1.00	50	49	53	49	39	31	—	52	48	49	47	38	34	18		
	1.50	51	50	55	49	40	31	—	53	49	51	49	42	40	20		
	3.00	54	53	57	53	43	34	11	54	52	55	53	49	48	24		
100/100	.50	46	45	47	43	35	26	—	51	45	43	41	31	24	12		
	1.00	47	46	47	44	36	27	—	51	45	45	42	36	34	13		
	1.50	48	46	48	44	36	27	—	51	46	46	44	40	40	15		
	3.00	48	48	50	45	38	30	—	52	47	49	48	47	48	23		
0/200	—	46	44	47	42	34	24	—	51	44	44	41	30	20	12		

- NOTES:**
1. ΔP_s static pressure difference from inlet to discharge.
 2. ΔP_s is the minimum required to deliver CFM shown in the primary damper in open position.
 3. ΔP_s does not include hot water or electric coils.
 4. Dash (—) indicates NC level less than 10.

NC levels are derived from tests conducted in accordance with ARI Standard 880-98 and are calculated in accordance with Appendix E of ARI Standard 885-98 as application data based on the following:

Discharge NC levels are based on -

- a) 5 foot rectangular duct lined with 1" fiberglass insulation.
- b) 6 foot lined flex duct (8" diameter).
- c) Maximum of 300 CFM per outlet.
- d) Space effect factor (5000 ft³) at 10 feet from outlet.
- e) End reflection.
- f) Environment adjustment factor.

Radiated NC levels are based on -

- a) Plenum/ceiling effect - 5/8" mineral fiber tile, 35 lb/ft³ - 3 foot plenum
- b) Space effect factor (5000 ft³) at 10 feet from source.
- c) Environment adjustment factor.

FAN POWERED UNITS



ARI Standard 880
A Participating Member
in the ARI 880
Certification Program

PERFORMANCE DATA – Constant Volume (Series Flow), Low Profile Design

**UNIT SIZE - L3
Inlet Size - 7”**

(FAN ON — 100% Primary Air/Mix/100% Secondary Air)

Primary/ Secondary CFM	Primary Air ΔP_s	Discharge Sound							Radiated Sound								
		Sound Power db							Max. NC	Sound Power db							Max. NC
		Octave Band								Octave Band							
2	3	4	5	6	7	2	3	4	5	6	7						
680/0	.24	68	67	66	66	64	62	26	70	63	59	58	49	40	30		
	.50	70	69	68	67	66	63	28	70	63	60	59	51	41	31		
	1.00	71	69	68	67	66	63	28	71	64	62	61	52	43	33		
	1.50	71	69	67	67	66	63	28	71	65	63	61	53	45	33		
	3.00	72	70	68	68	67	64	29	74	67	64	64	55	51	36		
340/340	.50	67	65	66	65	64	62	26	68	60	57	56	48	39	27		
	1.00	67	66	66	65	64	62	26	68	60	58	57	49	41	28		
	1.50	67	66	66	65	64	62	26	68	61	59	57	50	43	28		
	3.00	67	66	66	65	64	62	26	68	62	61	60	53	50	32		
0/680	—	66	64	65	65	63	62	26	68	59	55	56	48	39	27		
450/0	.11	57	57	59	57	54	50	14	59	53	52	52	40	28	23		
	.50	59	57	60	59	56	51	15	61	55	53	55	42	32	26		
	1.00	60	58	60	60	56	52	16	62	56	56	56	44	37	27		
	1.50	61	59	61	60	57	52	16	63	57	57	57	46	41	28		
	3.00	63	61	62	61	57	52	18	64	59	61	61	52	50	33		
225/225	.50	58	56	59	57	55	51	14	59	52	51	51	40	31	22		
	1.00	58	57	59	57	55	51	15	59	53	53	51	42	37	22		
	1.50	58	57	59	57	55	51	15	60	53	54	53	44	41	24		
	3.00	59	57	59	58	55	51	15	60	55	56	55	50	48	26		
0/450	—	57	55	57	57	54	50	14	60	51	50	50	40	28	21		
300/0	.05	51	50	52	49	44	38	-	54	47	45	46	33	22	17		
	.50	52	51	54	52	46	39	-	55	50	48	49	36	27	20		
	1.00	54	53	55	53	47	40	10	57	51	51	50	39	36	21		
	1.50	54	53	55	53	47	40	10	57	52	54	53	43	41	24		
	3.00	56	55	57	55	48	41	12	58	55	58	57	50	49	28		
150/150	.50	51	50	52	50	45	38	-	55	47	46	46	34	27	17		
	1.00	52	50	52	50	45	38	-	55	48	48	47	38	35	18		
	1.50	52	50	53	51	45	38	-	55	48	49	48	41	39	19		
	3.00	53	51	53	51	45	38	-	57	50	51	51	48	48	23		
0/300	—	50	50	52	50	45	38	-	56	46	45	47	33	21	18		

- NOTES:**
1. ΔP_s static pressure difference from inlet to discharge.
 2. ΔP_s is the minimum required to deliver CFM shown in the primary damper in open position.
 3. ΔP_s does not include hot water or electric coils.
 4. Dash (-) indicates NC level less than 10.

NC levels are derived from tests conducted in accordance with ARI Standard 880-98 and are calculated in accordance with Appendix E of ARI Standard 885-98 as application data based on the following:

Discharge NC levels are based on -

- a) 5 foot rectangular duct lined with 1” fiberglass insulation.
- b) 6 foot lined flex duct (8” diameter).
- c) Maximum of 300 CFM per outlet.
- d) Space effect factor (5000 ft³) at 10 feet from outlet.
- e) End reflection.
- f) Environment adjustment factor.

Radiated NC levels are based on -

- a) Plenum/ceiling effect - 5/8” mineral fiber tile, 35 lb/ft³ - 3 foot plenum
- b) Space effect factor (5000 ft³) at 10 feet from source.
- c) Environment adjustment factor.



ARI Standard 880
A Participating Member
in the ARI 880
Certification Program



PERFORMANCE DATA – Constant Volume (Series Flow), Low Profile Design

**UNIT SIZE - L4
Inlet Size - 8”**

(FAN ON — 100% Primary Air/Mix/100% Secondary Air)

Primary/ Secondary CFM	Primary Air ΔP_s	Discharge Sound							Radiated Sound								
		Sound Power db							Max. NC	Sound Power db							Max. NC
		Octave Band								Octave Band							
2	3	4	5	6	7	2	3	4	5	6	7						
1000/0	.27	75	73	72	71	69	69	32	74	67	63	62	54	45	34		
	.50	77	75	73	72	71	70	34	76	70	65	65	56	47	37		
	1.00	77	76	73	72	71	70	35	76	70	65	65	57	48	37		
	1.50	78	76	73	72	71	70	35	77	71	67	66	57	50	38		
	3.00	79	78	74	73	72	71	37	79	73	69	68	60	55	40		
500/500	.50	77	75	73	72	71	70	35	75	67	62	62	54	46	35		
	1.00	77	75	73	72	71	70	35	75	67	62	62	54	47	35		
	1.50	77	75	73	72	71	70	35	76	67	63	62	55	48	36		
	3.00	77	76	73	73	71	70	36	75	68	65	65	57	53	37		
0/1000	—	75	73	71	71	69	69	32	75	65	61	61	54	46	35		
750/0	.15	68	65	65	65	61	60	24	68	60	58	57	46	36	28		
	.50	70	68	67	66	64	62	26	71	63	59	61	50	40	33		
	1.00	70	68	67	67	64	62	26	71	64	61	61	50	43	33		
	1.50	71	68	67	67	64	62	26	71	65	63	63	52	46	35		
	3.00	72	69	68	67	65	62	27	72	67	66	66	56	53	38		
375/375	.50	69	67	66	66	63	62	26	71	60	57	58	49	40	30		
	1.00	70	67	66	66	63	62	26	71	61	58	58	50	42	30		
	1.50	70	67	66	66	63	62	26	71	62	60	59	51	45	31		
	3.00	70	67	67	66	63	62	26	71	63	62	63	54	51	35		
0/750	—	69	66	66	66	64	63	27	72	60	57	57	51	44	31		
500/0	.07	59	58	59	58	53	50	15	63	54	51	51	39	26	22		
	.50	61	60	61	60	56	52	17	65	56	55	55	43	33	26		
	1.00	63	60	61	60	56	52	17	65	58	56	56	45	39	27		
	1.50	63	61	61	61	56	52	18	65	59	59	58	48	44	30		
	3.00	63	62	62	61	56	52	19	66	62	64	63	53	52	35		
250/250	.50	61	59	59	59	55	53	17	65	54	52	52	41	32	23		
	1.00	62	59	59	59	55	53	17	66	55	54	54	44	38	25		
	1.50	62	59	59	59	55	53	17	66	56	55	55	46	43	26		
	3.00	62	60	60	60	55	53	18	66	58	58	59	51	50	31		
0/500	—	60	59	59	59	55	52	16	69	55	52	53	45	35	27		

- NOTES:**
1. ΔP_s static pressure difference from inlet to discharge.
 2. ΔP_s is the minimum required to deliver CFM shown in the primary damper in open position.
 3. ΔP_s does not include hot water or electric coils.
 4. Dash (—) indicates NC level less than 10.

NC levels are derived from tests conducted in accordance with ARI Standard 880-98 and are calculated in accordance with Appendix E of ARI Standard 885-98 as application data based on the following:

Discharge NC levels are based on -

- a) 5 foot rectangular duct lined with 1” fiberglass insulation.
- b) 6 foot lined flex duct (8” diameter).
- c) Maximum of 300 CFM per outlet.
- d) Space effect factor (5000 ft³) at 10 feet from outlet.
- e) End reflection.
- f) Environment adjustment factor.

Radiated NC levels are based on -

- a) Plenum/ceiling effect - 5/8” mineral fiber tile, 35 lb/ft³ - 3 foot plenum
- b) Space effect factor (5000 ft³) at 10 feet from source.
- c) Environment adjustment factor.



ARI Standard 880
A Participating Member
in the ARI 880
Certification Program

PERFORMANCE DATA – Constant Volume (Series Flow), Low Profile Design

**UNIT SIZE - L5
Inlet Size - 10”**

(FAN ON — 100% Primary Air/Mix/100% Secondary Air)

FAN POWERED UNITS

Primary/ Secondary CFM P _s	Primary Air Δ ₂	Discharge Sound							Max. 2	Radiated Sound						Max.
		Sound Power db Octave Band								Sound Power db Octave Band						
		3	4	5	6	7	NC	3		4	5	6	7	NC		
1525/0	.24	82	79	77	77	74	74	38	80	73	66	66	59	50	41	
	.50	84	79	77	77	75	74	39	82	74	67	67	60	51	44	
	1.00	84	81	78	78	76	74	41	82	75	69	69	62	53	44	
	1.50	85	81	79	78	77	75	41	83	77	70	70	62	54	45	
	3.00	86	81	79	79	77	75	41	85	79	43	73	64	58	48	
763/763	.50	81	78	76	76	74	73	37	77	71	65	66	59	51	38	
	1.00	81	78	76	76	74	73	37	77	71	66	66	60	51	38	
	1.50	81	78	76	76	74	74	37	77	71	66	67	60	51	39	
	3.00	81	78	77	77	76	75	38	79	72	68	69	61	55	41	
0/1525	—	80	77	75	75	73	72	36	77	70	63	64	58	49	37	
1200/0	.13	78	74	73	72	70	69	33	75	68	61	61	54	46	35	
	.50	78	75	74	73	71	69	34	76	69	63	64	56	47	36	
	1.00	78	75	74	73	71	69	34	78	71	65	65	57	48	39	
	1.50	78	75	74	73	71	69	34	79	72	66	67	58	50	40	
	3.00	81	77	75	74	72	70	36	80	74	70	70	61	56	42	
600/600	.50	78	74	72	72	69	69	34	73	67	61	62	54	46	34	
	1.00	78	74	72	72	69	69	34	73	67	62	63	55	47	35	
	1.50	78	74	73	72	69	69	34	73	67	63	64	55	49	36	
	3.00	78	74	73	73	70	69	34	76	69	65	67	58	53	39	
0/1200	—	78	72	72	69	68	31	73	64	60	60	54	45	32		
900/0	.08	70	65	66	65	62	60	24	66	59	56	55	48	38	26	
	.50	71	66	67	66	62	61	25	69	63	59	59	49	40	31	
	1.00	72	68	68	68	64	62	26	73	66	61	61	52	43	33	
	1.50	74	69	69	68	64	62	27	73	67	63	63	54	47	35	
	3.00	76	71	70	69	66	63	29	75	70	67	68	58	54	40	
450/450	.50	72	66	66	66	63	62	26	66	60	57	57	48	39	28	
	1.00	70	66	67	66	63	61	25	67	61	58	58	49	42	30	
	1.50	69	65	67	67	63	61	25	68	62	60	60	51	45	32	
	3.00	71	66	68	67	64	62	26	71	64	61	64	55	51	36	
0/900	—	69	64	66	65	62	61	25	67	58	55	56	48	38	27	

- NOTES:**
1. ΔP_S static pressure difference from inlet to discharge.
 2. ΔP_S is the minimum required to deliver CFM shown in the primary damper in open position.
 3. ΔP_S does not include hot water or electric coils.
 4. Dash (—) indicates NC level less than 10.

NC levels are derived from tests conducted in accordance with ARI Standard 880-98 and are calculated in accordance with Appendix E of ARI Standard 885-98 as application data based on the following:

Discharge NC levels are based on -

- a) 5 foot rectangular duct lined with 1” fiberglass insulation.
- b) 6 foot lined flex duct (8” diameter).
- c) Maximum of 300 CFM per outlet.
- d) Space effect factor (5000 ft³) at 10 feet from outlet.
- e) End reflection.
- f) Environment adjustment factor.

Radiated NC levels are based on -

- a) Plenum/ceiling effect - 5/8” mineral fiber tile, 35 lb/ft³ - 3 foot plenum
- b) Space effect factor (5000 ft³) at 10 feet from source.
- c) Environment adjustment factor.



ARI Standard 880
A Participating Member
in the ARI 880
Certification Program



MODEL NUMBERING – Constant Volume (Series Flow), Low Profile Design

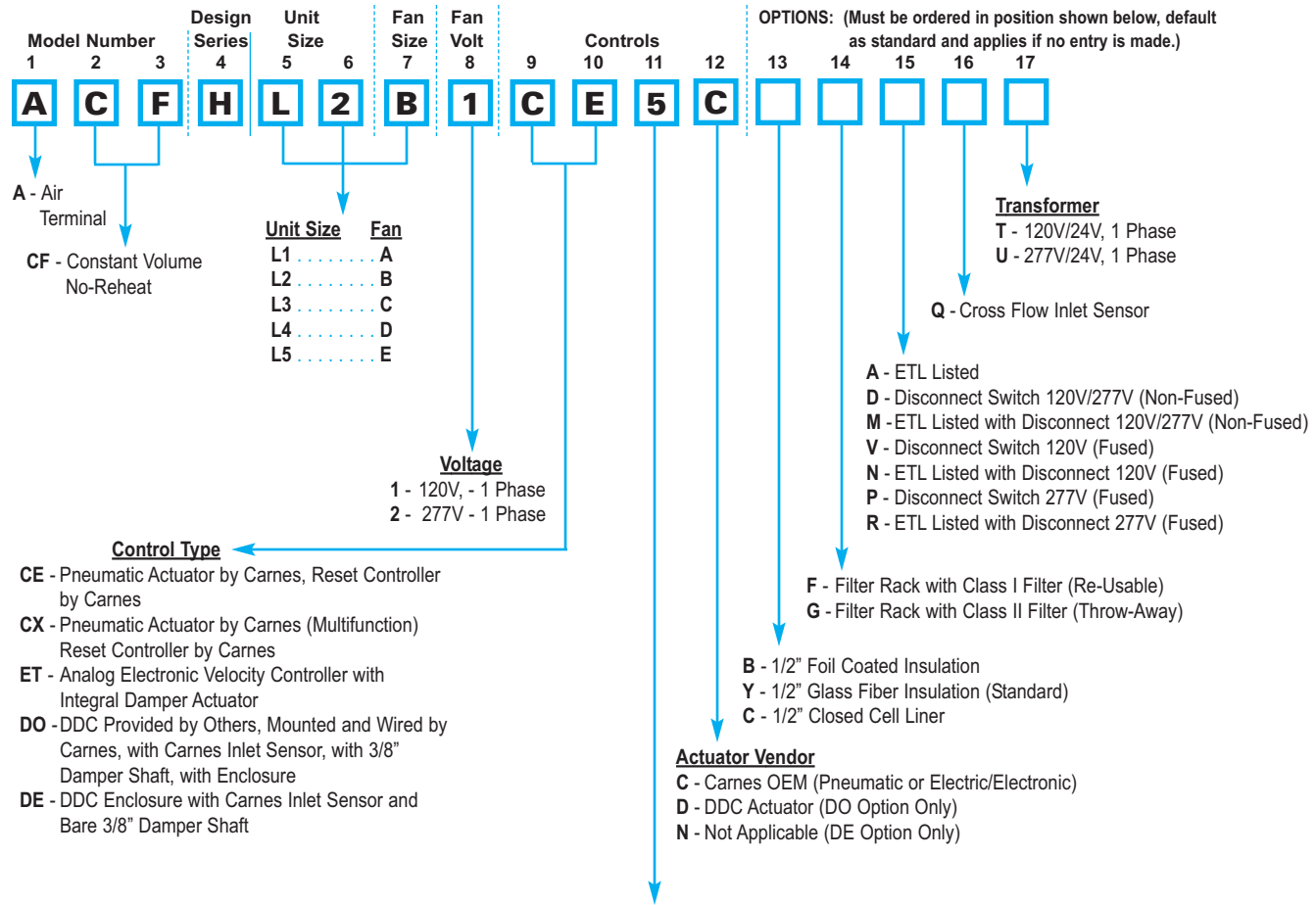

Controls and Damper Arrangement

NOTE: Hand of controls is determined by facing the averaging flow sensor (inlet of the unit) with the supply air hitting the back of your head.

- *1 - Normally Open - Right Hand Controls (Electronic/DO, DE & ET) (All Pneumatic Control Types for Reverse Acting Thermostat)
- *2 - Normally Open - Left Hand Controls (Electronic/DO, DE & ET) (All Pneumatic Control Types for Reverse Acting Thermostat)
- 3 - Normally Closed - Right Hand Controls (All Pneumatic Control Types for Direct Acting Thermostat)
- 4 - Normally Closed - Left Hand Controls (All Pneumatic Control Types for Direct Acting Thermostat)
- 5 - Normally Open - Right Hand Controls (All Pneumatic Control Types for Direct Acting Thermostat)
- 6 - Normally Open - Left Hand Controls (All Pneumatic Control Types for Direct Acting Thermostat)
- 7 - Normally Closed - Right Hand Controls (All Pneumatic Control Types for Reverse Acting Thermostat)
- 8 - Normally Closed - Left Hand Controls (All Pneumatic Control Types for Reverse Acting Thermostat)

Electronic Thermostat

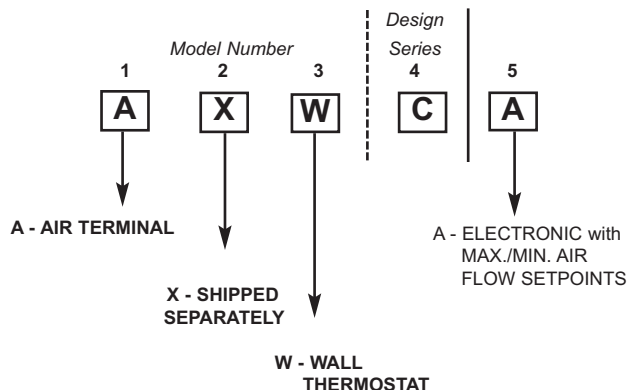

*Electronic and DDC Units DO NOT Fail Open, "1" or "2" is used for Right or Left Hand Only. Electronic Units are shipped with the Damper in Open Position.

A Carnes Electronic Thermostat **must be ordered** with the Electronic ET Control Option.

DIMENSIONAL DATA – Constant Volume (Series Flow), Low Profile Design

FAN POWERED UNITS

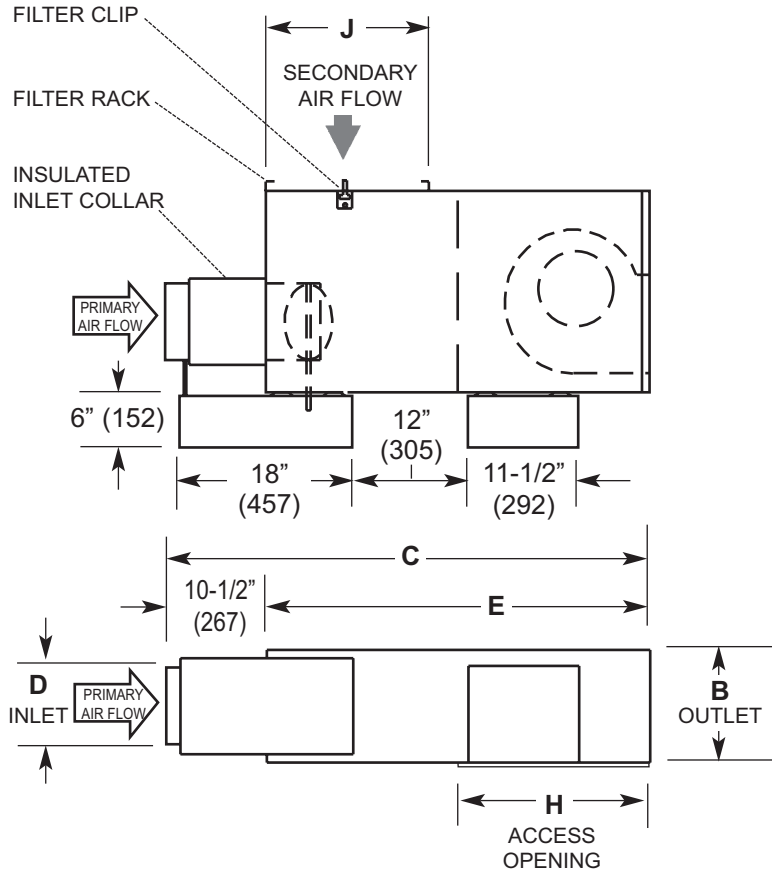

RIGHT HAND PRIMARY AIR UNIT SHOWN. LEFT HAND AVAILABLE.

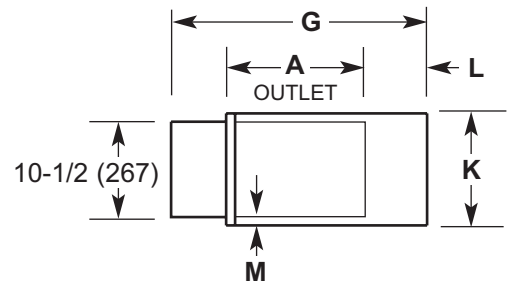

DIMENSIONS LISTED IN INCHES (Millimeters)

Unit Size	Fan Size	Inlet Size	Primary CFM	Secondary CFM @ .25 E.S.P.	Fan H.P.	Outlet		C	D	E	G	H	J	K	L	M
						A	B									
L1	A	05	350	290	1/6				4-7/8 (124)							
L2	B	06	500	420	1/6	9-1/2 (241)	7 (178)	50-1/2 (1283)	5-7/8 (149)	40 (1016)	27 (685)	19-1/4 (489)	16 (406)	10-1/2 (267)	9 (229)	1-1/4 (32)
L3	C	07	700	680	1/6				6-7/8 (175)							
L4	D	08	1000	1000	1/4	10 (254)	7 (178)		7-7/8 (200)						9-1/4 (235)	
L5	E	10	1500	1525	1/2	11 (279)	8-1/4 (210)	50-1/2 (1283)	9-7/8 (251)	40 (1016)	27 (685)	19-1/4 (489)	17 (432)	12-1/2 (318)	8 (203)	--

NOTE: Outlet dimensions refer to the actual opening.

MODEL NUMBERING – Constant Volume (Series Flow), Low Profile Design

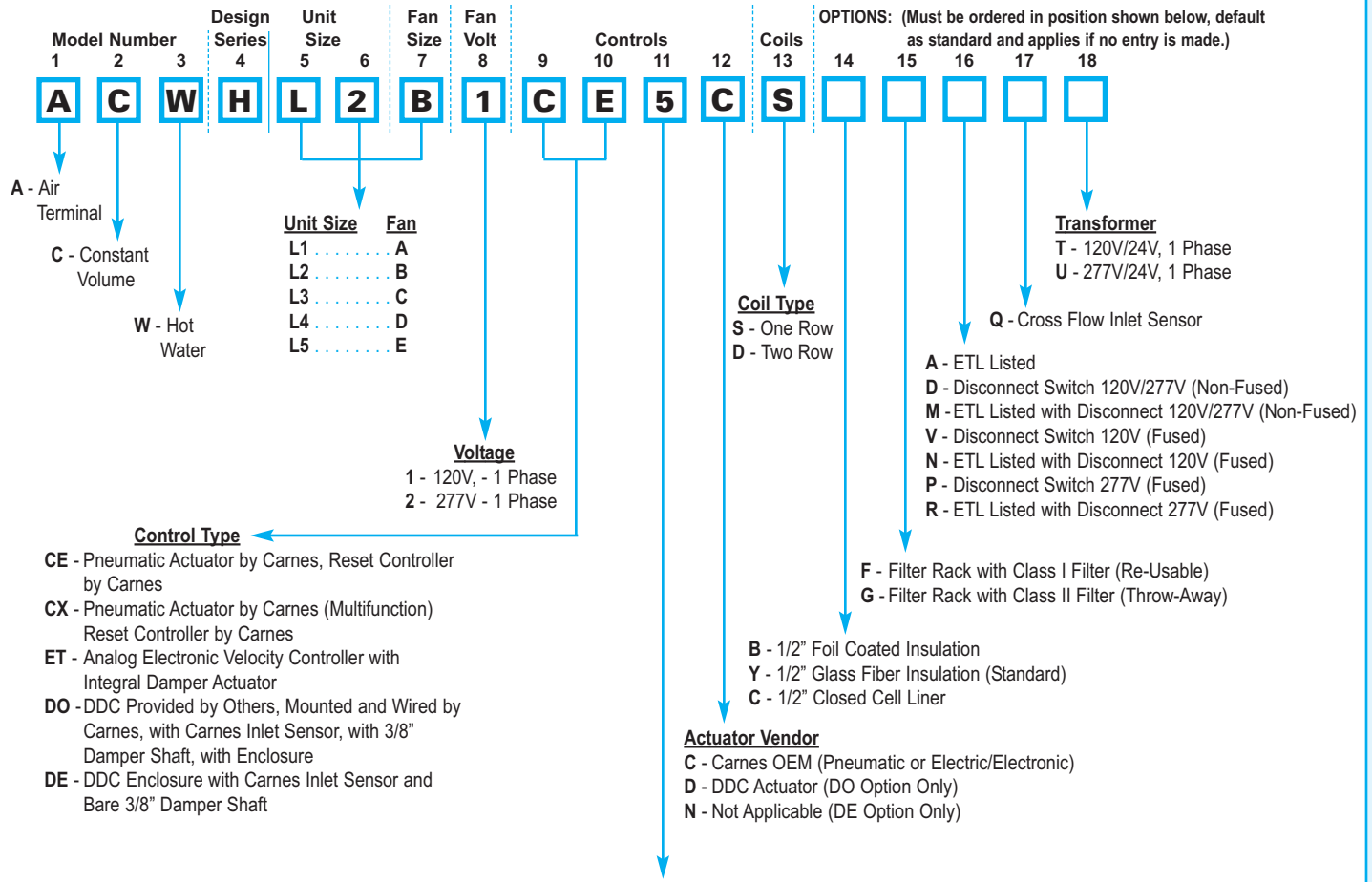

Controls and Damper Arrangement

NOTE: Hand of controls is determined by facing the averaging flow sensor (inlet of the unit) with the supply air hitting the back of your head.

- *1 - Normally Open - Right Hand Controls (Electronic/DO, DE & ET) (All Pneumatic Control Types for Reverse Acting Thermostat)
- *2 - Normally Open - Left Hand Controls (Electronic/DO, DE & ET) (All Pneumatic Control Types for Reverse Acting Thermostat)
- 3 - Normally Closed - Right Hand Controls (All Pneumatic Control Types for Direct Acting Thermostat)
- 4 - Normally Closed - Left Hand Controls (All Pneumatic Control Types for Direct Acting Thermostat)
- 5 - Normally Open - Right Hand Controls (All Pneumatic Control Types for Direct Acting Thermostat)
- 6 - Normally Open - Left Hand Controls (All Pneumatic Control Types for Direct Acting Thermostat)
- 7 - Normally Closed - Right Hand Controls (All Pneumatic Control Types for Reverse Acting Thermostat)
- 8 - Normally Closed - Left Hand Controls (All Pneumatic Control Types for Reverse Acting Thermostat)

Electronic Thermostat

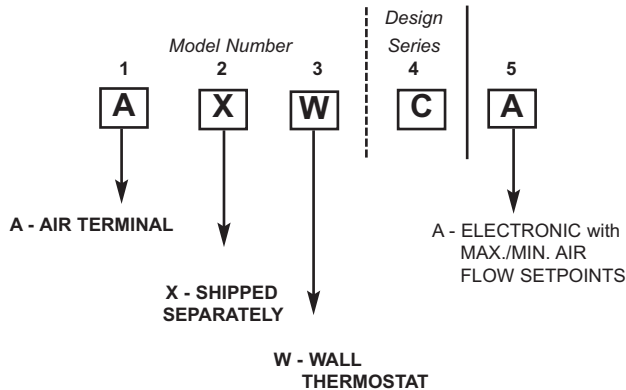

*Electronic and DDC Units DO NOT Fail Open, "1" or "2" is used for Right or Left Hand Only. Electronic Units are shipped with the Damper in Open Position.

A Carnes Electronic Thermostat **must be ordered** with the Electronic ET Control Option.

DIMENSIONAL DATA – Constant Volume (Series Flow), Low Profile Design

FAN POWERED UNITS

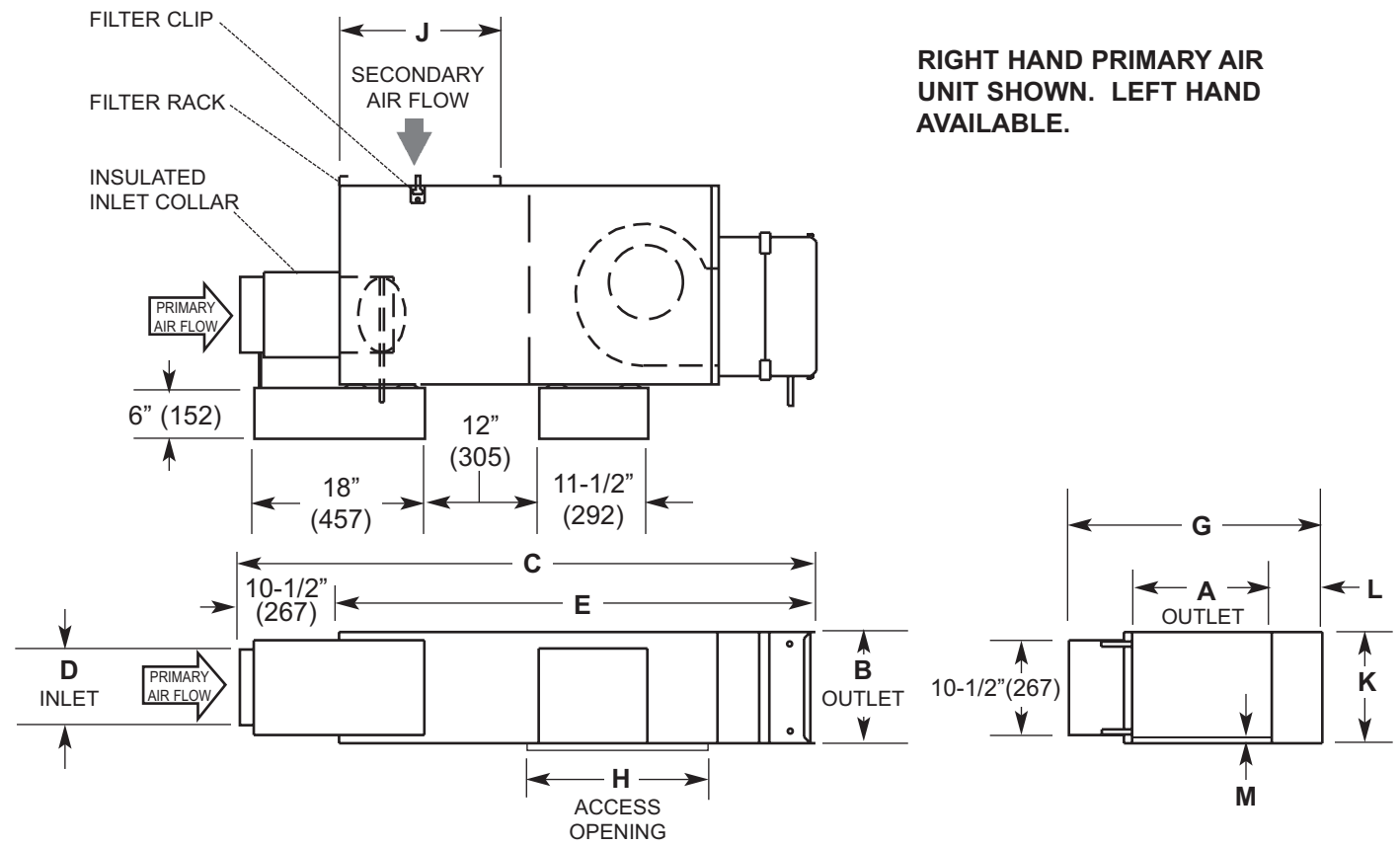

DIMENSIONS LISTED IN INCHES (Millimeters)

Unit Size	Fan Size	Inlet Size	Primary CFM	Secondary CFM @ .25 E.S.P.	Fan H.P.	Outlet		C 1-Row	C 2-Row	D	E 1-Row	E 2-Row	G	H	J	K	L	M
						A	B											
L1	A	05	350	290	1/6					4-7/8 (124)								
L2	B	06	450	420	1/6	12 (305)	10 (254)	56-1/2 (1435)	58 (1473)	5-7/8 (149)	46-1/8 (1172)	47-1/2 (1207)	27 (685)	19-1/4 (489)	16 (406)	10-1/2 (267)	8-1/2 (216)	1/2 (13)
L3	C	07	700	680	1/6					6-7/8 (175)								
L4	D	08	1000	1000	1/4					7-7/8 (200)								
L5	E	10	1500	1525	1/2	14 (356)	12-1/2 (318)	56-1/2 (1435)	58 (1473)	9-7/8 (251)	46-1/8 (1172)	47-1/2 (1207)	27 (685)	19-1/4 (489)	17 (432)	12-1/2 (318)	7 (178)	--

NOTE: Outlet is designed for slip and drive duct connection.

MODEL NUMBERING – Constant Volume (Series Flow), Low Profile Design

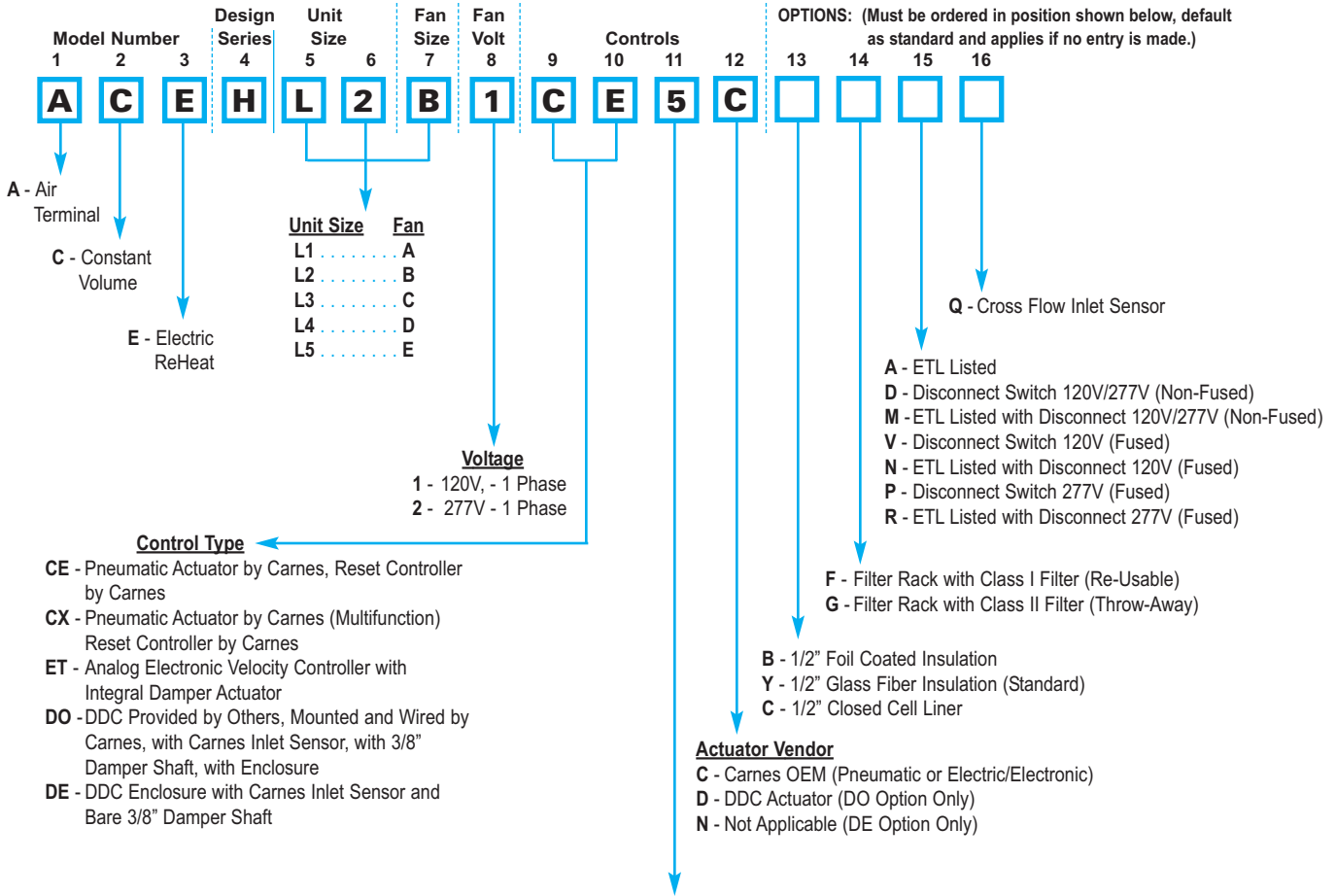

Controls and Damper Arrangement

NOTE: Hand of controls is determined by facing the averaging flow sensor (inlet of the unit) with the supply air hitting the back of your head.

- *1 - Normally Open - Right Hand Controls (Electronic/DO, DE & ET) (All Pneumatic Control Types for Reverse Acting Thermostat)
- *2 - Normally Open - Left Hand Controls (Electronic/DO, DE & ET) (All Pneumatic Control Types for Reverse Acting Thermostat)
- 3 - Normally Closed - Right Hand Controls (All Pneumatic Control Types for Direct Acting Thermostat)
- 4 - Normally Closed - Left Hand Controls (All Pneumatic Control Types for Direct Acting Thermostat)
- 5 - Normally Open - Right Hand Controls (All Pneumatic Control Types for Direct Acting Thermostat)
- 6 - Normally Open - Left Hand Controls (All Pneumatic Control Types for Direct Acting Thermostat)
- 7 - Normally Closed - Right Hand Controls (All Pneumatic Control Types for Reverse Acting Thermostat)
- 8 - Normally Closed - Left Hand Controls (All Pneumatic Control Types for Reverse Acting Thermostat)

Electronic Thermostat

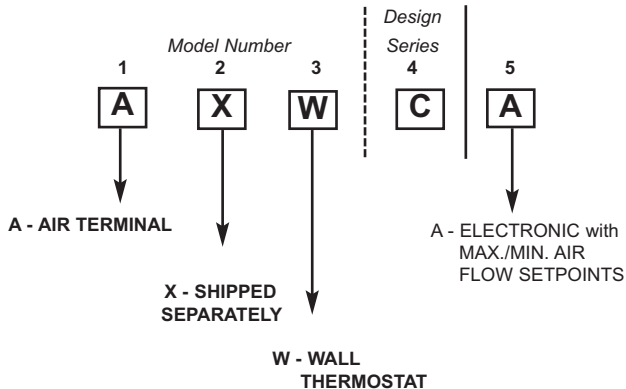

*Electronic and DDC Units DO NOT Fail Open, "1" or "2" is used for Right or Left Hand Only. Electronic Units are shipped with the Damper in Open Position.

A Carnes Electronic Thermostat **must be ordered** with the Electronic ET Control Option.

FAN POWERED UNITS

DIMENSIONAL DATA – Constant Volume (Series Flow), Low Profile Design

FAN POWERED UNITS

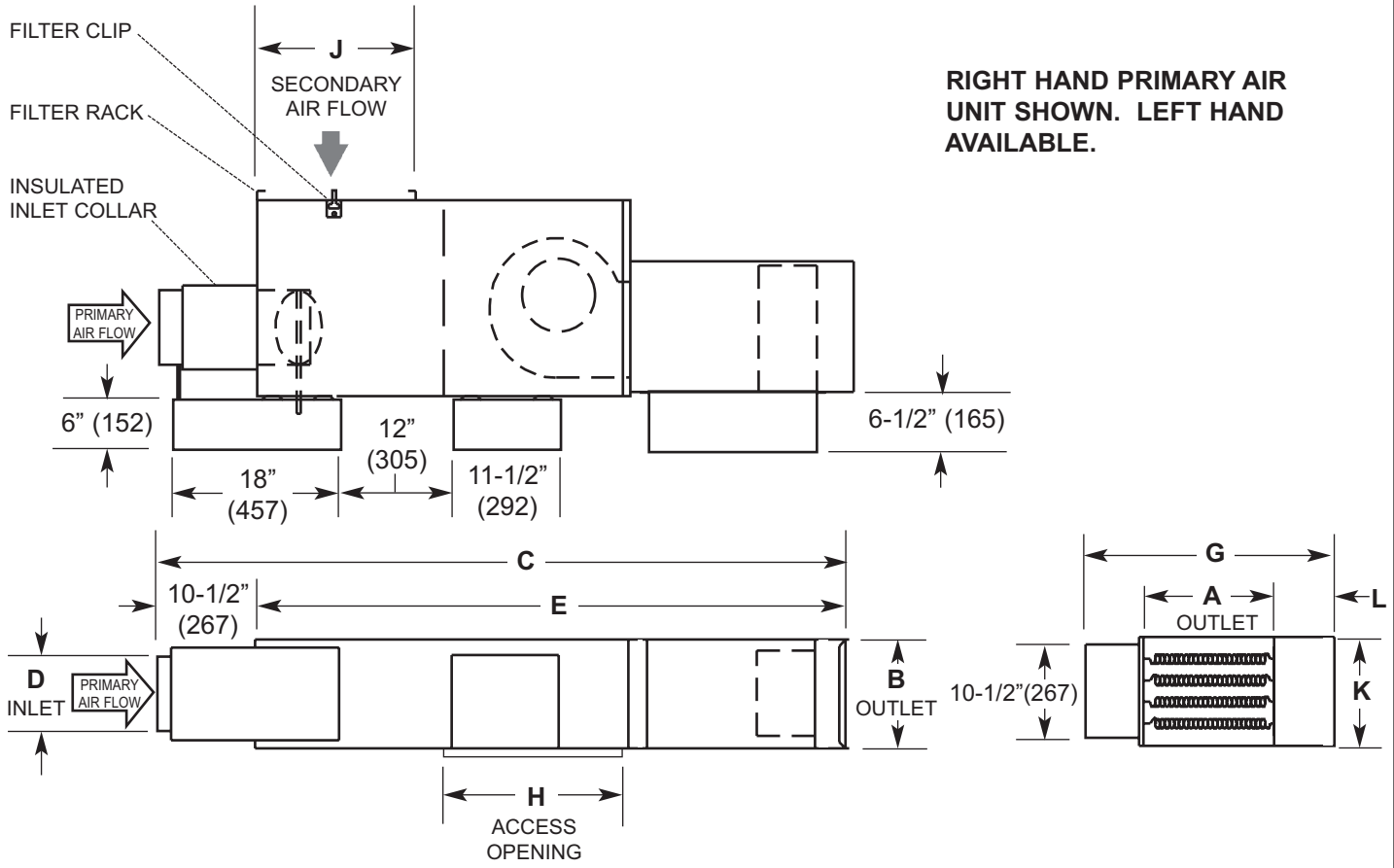

DIMENSIONS LISTED IN INCHES (Millimeters)

Unit Size	Fan Size	Inlet Size	Primary CFM	Secondary CFM @ .25 E.S.P.	Fan H.P.	Outlet		C	D	E	G	H	J	K	L	
						A	B									
L1	A	05	350	290	1/6				4-7/8 (124)							
L2	B	06	500	420	1/6	12 (305)	10-1/2 (267)	72-3/4 (1848)	5-7/8 (149)	62-1/4 (1581)	27 (685)	19-1/4 (489)	16 (406)	10-1/2 (267)	8 (203)	
L3	C	07	700	680	1/6				6-7/8 (175)							
L4	D	08	1000	1000	1/4				7-7/8 (200)						7-1/2 (191)	
L5	E	10	1500	1525	1/2	14 (356)	12-1/2 (318)	72-3/4 (1848)	9-7/8 (251)	62-1/4 (1581)	27 (685)	19-1/4 (489)	17 (432)	12-1/2 (318)	7 (178)	

NOTE: Outlet is designed for slip and drive duct connection.