

Model ASF w/o Reheat

Model ASW w/Hot Water Reheat

Model ATF w/o Reheat

Model ATW w/Hot Water Reheat

Model ASE w/Electric Reheat

Model ATE w/Electric Reheat

The Carnes intermittent fan terminal unit provides constant air volume to the space for reheat applications while retaining a variable air volume system during normal cooling operation.

The primary air control assembly operates independently as a standard throttling valve for cooling loads. As cooling loads diminish, the secondary air supply fan(s) is energized to induce warm ceiling plenum air. A wide variety of control sequences makes this fan powered unit compatible with the most energy efficient system design.

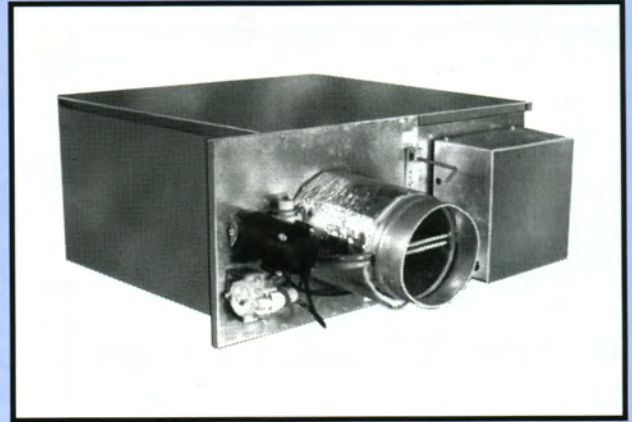

Other Features Include:

- Fourteen unit sizes offering air flow capacities to 7300 CFM primary air and 3400 CFM secondary air with low pressure drop and low sound levels.
- Durable 22 gauge galvanized steel casing construction.
- Standard inlet and discharge connections.
- Forward curved centrifugal type fan assemblies with three speed, thermally protected, permanent split capacitor type 115 or 277 volt fractional horsepower motors.
- Fan/motor assemblies are isolated from the casing using rubber isolators to minimize vibration transmission.
- Field adjustable fan air flow damper (between three speeds).
- Field adjustable P/E switch with pneumatic controls.
- Performance data based on tests conducted in accordance with ARI Standard 880-94.
- Averaging type velocity sensor and calibration chart for measuring primary air flow.
- Secondary air filter rack.
- All units equipped with pneumatic or electronic pressure independent controls.
- Insulation is 1" thick, 1-1/2 lb. dual density fiberglass with surface treatment to prevent air erosion. UL listed and meets NFPA 90A requirements.
- Low leakage primary air damper design.
- Optional ETL listing.
- Optional fan speed selector switch.
- Optional primary air controls enclosure.
- Optional secondary air sound baffle. Sound baffle is factory attached to secondary air inlet.
- Optional one or two row hot water coils (Models ASW and ATW). Coil is factory attached to primary air discharge.
- Optional electric reheat coils (Models ASE and ATE). Coil is factory attached to primary air discharge, or shipped separately for field mounting.
- Optional secondary air filters, Class I (re-usable) and Class II (throw away).
- Optional non-fused fan disconnect switch.
- Optional foil coated insulation (Hospital, Laboratory, etc. applications).

Available Modules:

- Basic control unit — **Models ASF/ATF.**
- Basic control unit with hot water coil — **Models ASW/ATW.**
- Basic control unit with or without electric coil — **Models ASE/ATE**

Typical Sequence of Operation

Central fan on — Day (occupied) operation.

When the central system fan is "on", the intermittent fan unit operates as a standard throttling control unit for cooling loads. As the cooling load diminishes the control valve throttles to a minimum or closed position, the fan is energized by the P/E switch for pneumatic controls or an electric contactor for electronic controls to draw in warm plenum air. Thermostat is calling for heat.

Central fan off — Night (unoccupied) operation.

When the central system fan is "off", on a call for less cooling, the primary air supply valve closes. The unit fan is then turned on and off by the P/E switch for pneumatic controls or an electric contactor for electronic controls on demands for heat and not heat respectively.

CAUTION: For electronically controlled units, a minimum CFM value other than zero may cause the damper to drive open when the central system is off.

PERFORMANCE DATA — Intermittent Volume Fan Terminal Units

Fan Unit Model	Unit Size	Motor(s) H. P.	120 Volt Motor(s) FLA	277 Volt Motor(s) FLA
AS	06	1 @ 1/6	2.0	.8
AT	08			
AS	07	1 @ 1/6	2.0	.8
AT	10			
AS	08	1 @ 1/5	2.2	.9
AT	12			
AS	10	1 @ 1/4	3.2	1.2
AT	14			
AS	12	1 @ 1/2	6.2	2.3
AT	16			
AS	14	2 @ 1/4	6.4	2.4
AT	18			
AS	16	2 @ 1/2	12.4	4.6
AT	24			

FAN CURVES — CFM vs External Static Pressure

Models AS 06 & 07 - AT 08-10

1/6 H. P. Motor

F. L. A.: 2.0A @ 120V .8A @ 277 V

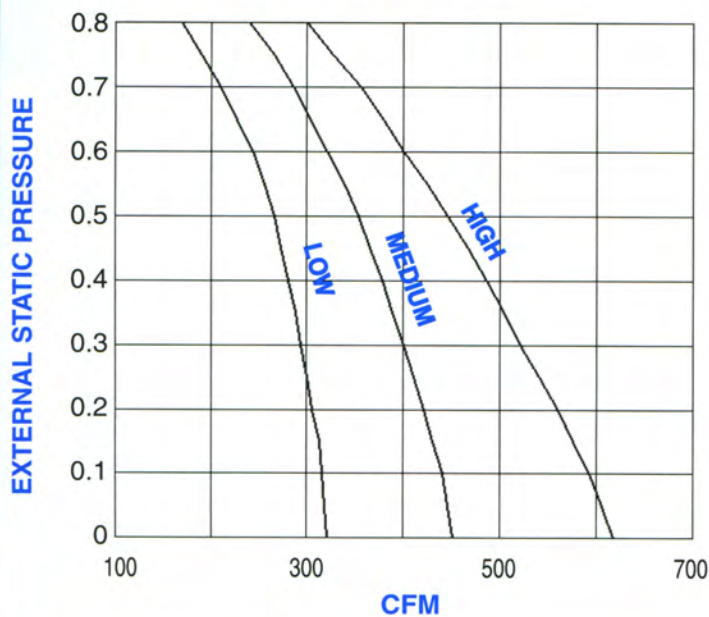

Models AS 08 - AT 12

1/5 H. P. Motor

F. L. A.: 2.2A @ 120V .9A @ 277 V

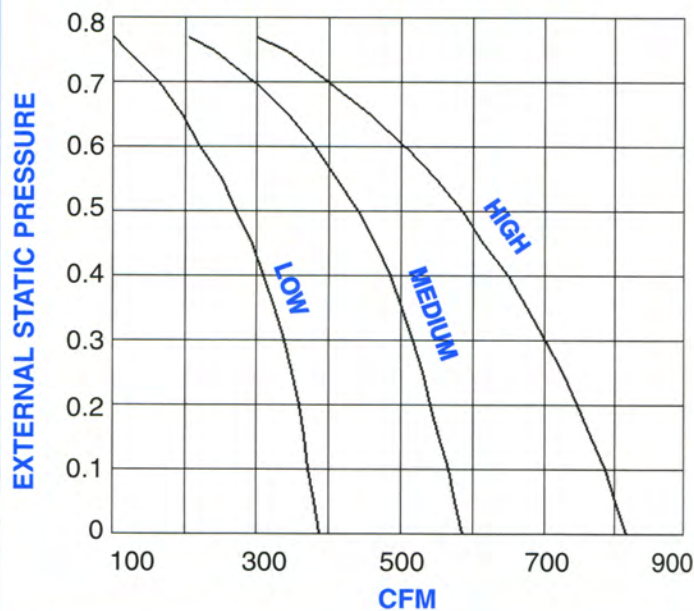

- NOTES:**
1. External static pressure (ESP) consist of downstream ductwork, coils, flex duct, etc.
 2. Pressure drops due to heating coils are treated as external static pressures (Refer to coil sections of this catalog for additional information.)
 3. F. L. A. = Full Load Amps of motor.

FAN CURVES — CFM vs External Static Pressure

Models AS 10 - AT 14

1/4 H. P. Motor
F. L. A.: 3.2A @ 120V 1.2A @ 277 V

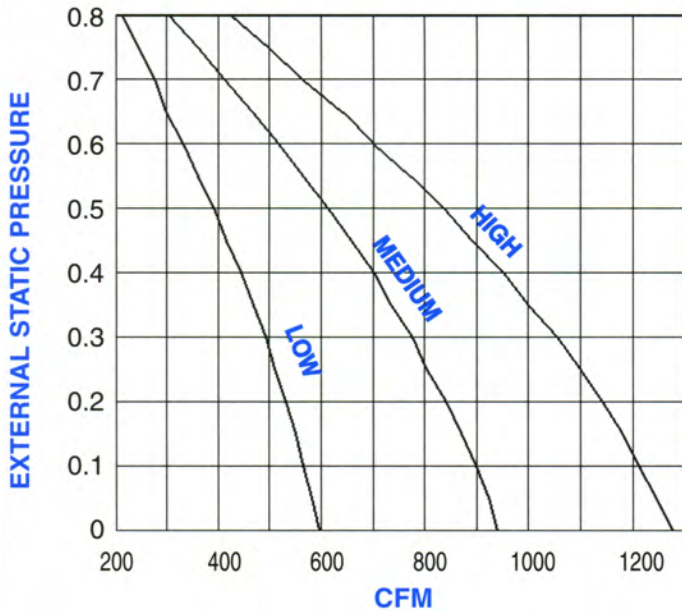

Models AS 12 - AT 16

1/2 H. P. Motor
F. L. A.: 6.2A @ 120V 2.3A @ 277 V

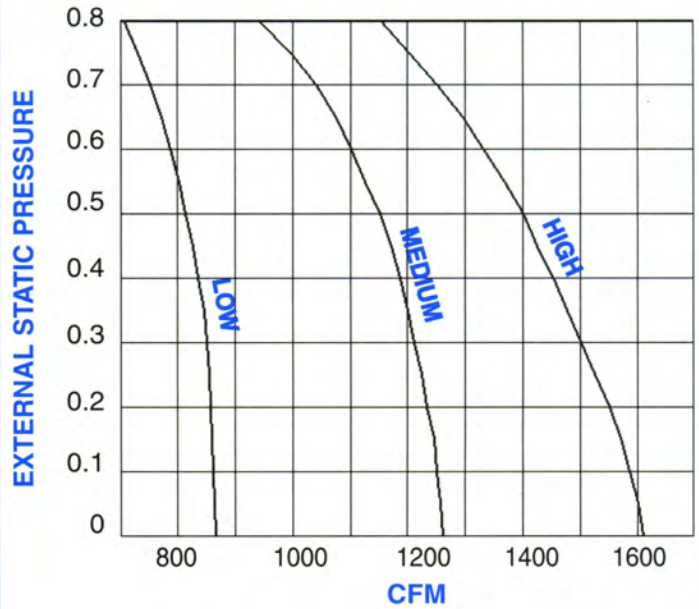

Model AS 14

(2) 1/4 H. P. Motors
F. L. A.: 6.4A @ 120V 2.4A @ 277 V

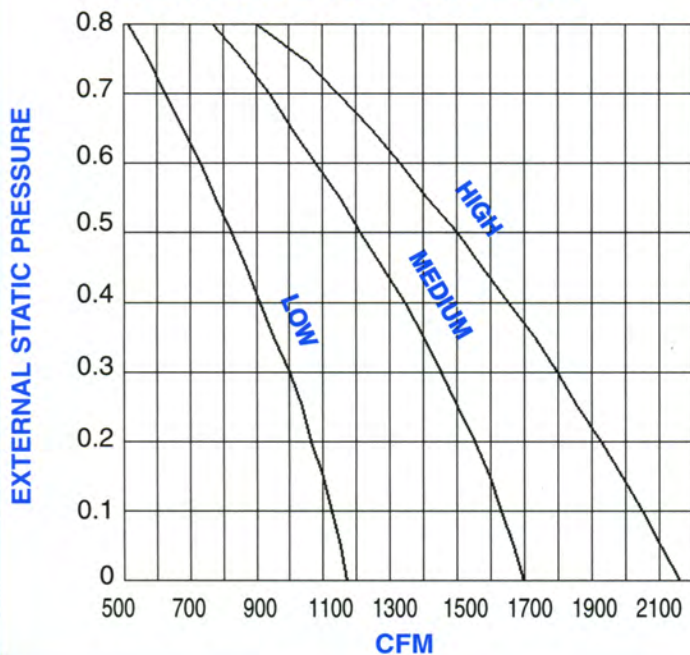

Model AS 16

(2) 1/2 H. P. Motors
F. L. A.: 12.4A @ 120V 4.6A @ 277 V

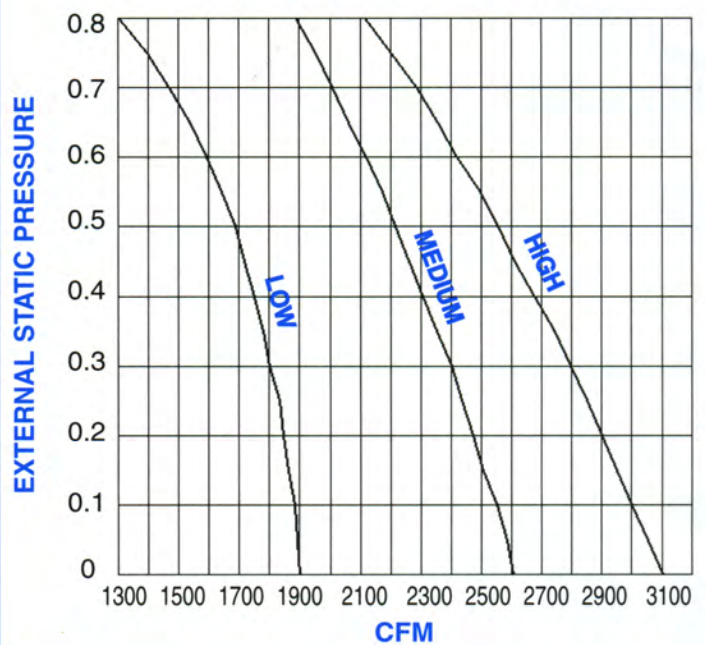

- NOTES:**
1. External static pressure (ESP) consist of downstream ductwork, coils, flex duct, etc.
 2. Pressure drops due to heating coils are treated as external static pressures (Refer to coil sections of this catalog for additional information.)
 3. F. L. A. = Full Load Amps of motor.

FAN CURVES CFM vs External Static Pressure

Model AT 18

(2) 1/4 H. P. Motors

F. L. A.: 6.4A @ 120V 2.4A @ 277 V

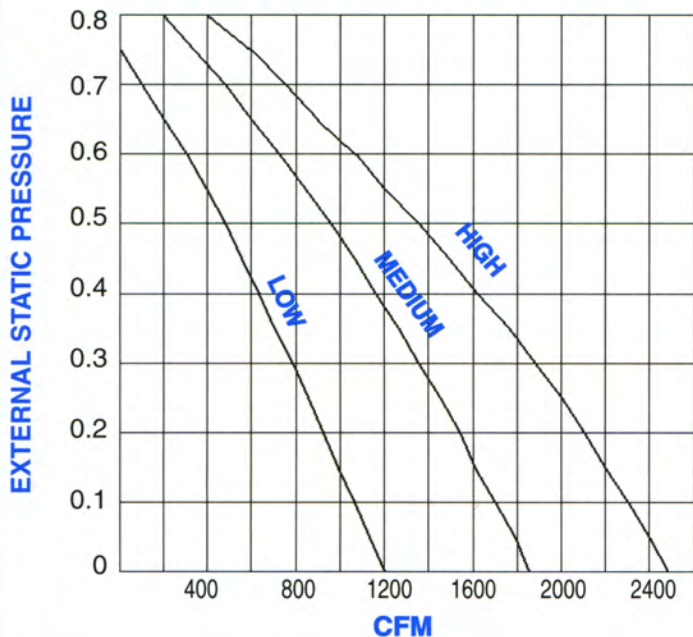

Model AT 24

(2) 1/2 H. P. Motors

F. L. A.: 12.4A @ 120V 4.6A @ 277 V

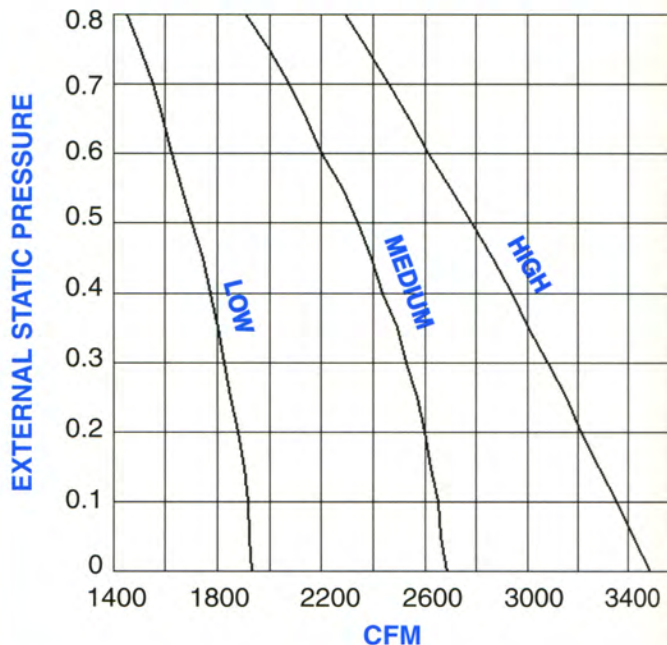

SOUND PERFORMANCE DATA

Radiated Sound Data with and without Attached Sound Baffle (FAN ON)

Fan Speed	ESP	Unit Size	CFM	With Sound Baffle	No Sound Baffle	Unit Size	CFM	With Sound Baffle	No Sound Baffle
				Radiated NC	Radiated NC			Radiated NC	Radiated NC
HI	.25	AS06	495	22	27	AT08	495	22	27
MED	.25		400	18	22		400	18	22
LOW	.25		290	14	18		290	14	18
HI	.25	AS07	495	22	27	AT10	495	22	27
MED	.25		400	18	22		400	18	22
LOW	.25		290	14	18		290	14	18
HI	.25	AS08	640	21	25	AT12	640	2	25
MED	.25		490	19	23		490	19	23
LO	.25		305	15	20		305	15	20
HI	.25	AS10	975	19	21	AT14	975	19	21
MED	.25		755	16	18		755	16	18
LO	.25		515	14	15		515	14	15
HI	.25	AS12	1315	25	28	AT16	1315	25	28
MED	.25		1145	22	21		1145	22	21
LO	.25		850	15	18		850	15	18
HI	.25	AS14	1770	27	28	AT18	1780	27	28
MED	.25		1550	22	23		1370	22	23
LO	.25		1040	18	20		795	18	20
HI	.25	AS16	2675	27	28	AT24	3030	27	28
MED	.25		2361	23	24		2505	23	24
LO	.25		1785	20	21		1810	20	21

- NOTES:**
1. Performance data on this page is considered to be application data. Although this data is presented in a format that cannot be certified, it is based on testing in accordance with ARI Standard 880. Certified performance data is shown on page 67.
 2. Secondary Air Sound Data is tested with the primary air damper closed..
 3. External Static Pressure (ESP) is pressure due to the air flow adjustment damper, heating coils, and/or downstream ductwork.
 4. The CFM indicated is the maximum attainable at the external static pressure (ESP) shown.

Radiated NC levels are based on:

- a) Plenum/ceiling effect - 5/8" mineral fiber tile, 35 lb./ft³.
- 3 foot plenum.
- b) Space effect factor (5000 ft³) at 10 feet from outlet.
- c) 10 db for room absorption.

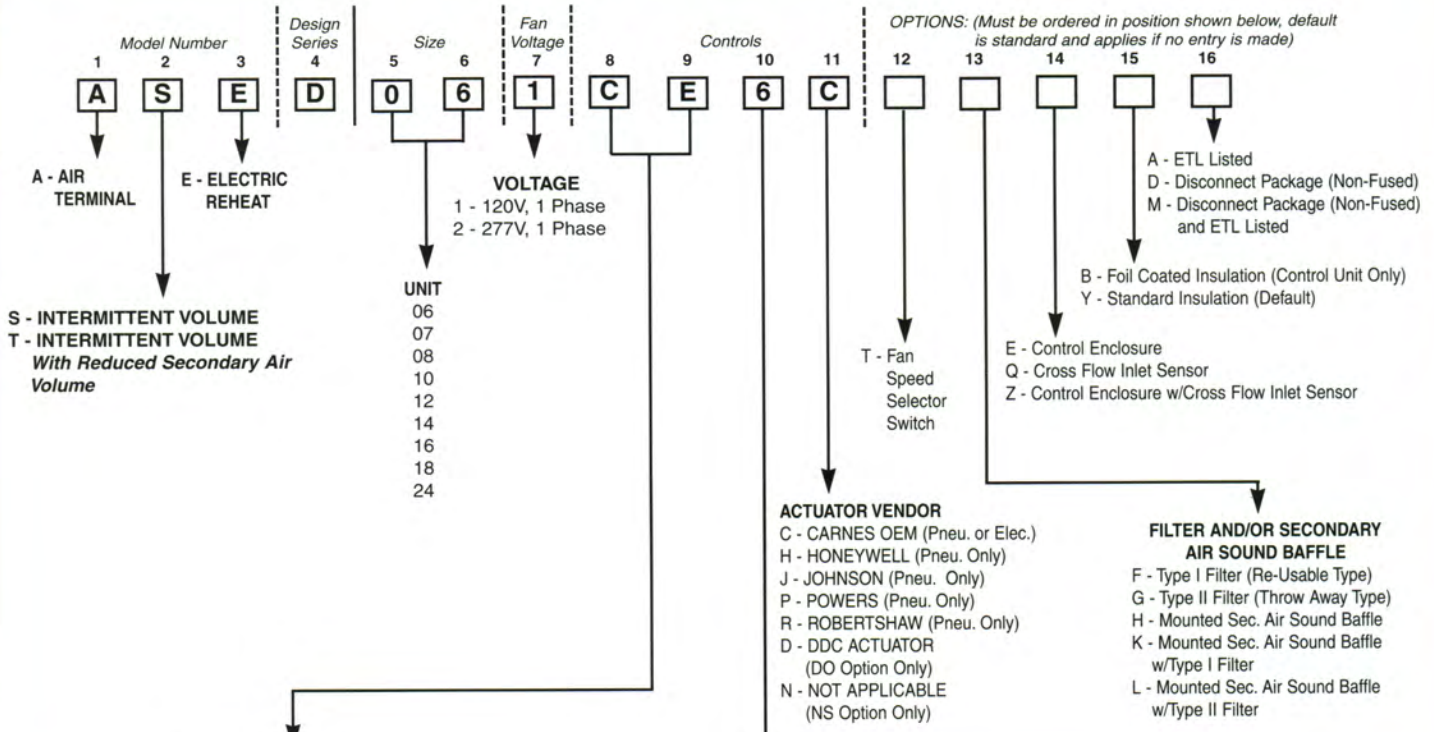

- CONTROL TYPE**
- CE - Pneumatic Actuator by Carnes, Reset Controller by Carnes
 - CX - Pneumatic Actuator by Carnes, (Multi-function) Reset Controller by Carnes
 - PE - Pneumatic Actuator by Others, Mounted by Carnes, Reset Controller by Carnes
 - PX - Pneumatic Actuator by Others, Mounted by Carnes, (Multi-function) Reset Controller by Carnes
 - ET - Analog Electronic Velocity Controller with Integral Damper Actuator
 - DO - DDC Provided by Others, Mounted and Wired by Carnes, with Carnes Inlet Sensor, with 3/8" Damper Shaft
 - NS - No Damper Controls, with Carnes Inlet Sensor, with bare 3/8" Damper Shaft
 - NA - No Damper Controls with Carnes Inlet Sensor, with Pneumatic Actuator Linkage (Must Specify Vendor)

A Carnes Electronic Thermostat **must be ordered** with the Electronic ET Control Option.

NOTE: Hand of controls is determined by facing the averaging flow sensor (inlet of the unit) with the supply air hitting the back of your head.

- CONTROLS AND DAMPER ARRANGEMENT**
- *1 - Normally Open - Right Hand Controls (Electronic/DO, NS, NA)
(All Pneumatic Control Types for Reverse Acting Thermostat)
 - *2 - Normally Open - Left Hand Controls (Electronic/DO, NS, NA)
(All Pneumatic Control Types for Reverse Acting Thermostat)
 - 3 - Normally Closed - Right Hand Controls (All Pneumatic Control Types for Direct Acting Thermostat)
 - 4 - Normally Closed - Left Hand Controls (All Pneumatic Control Types for Direct Acting Thermostat)
 - 5 - Normally Open - Right Hand Controls (All Pneumatic Control Types for Direct Acting Thermostat)
 - 6 - Normally Open - Left Hand Controls (All Pneumatic Control Types for Direct Acting Thermostat)
 - 7 - Normally Closed - Right Hand Controls (All Pneumatic Control Types for Reverse Acting Thermostat)
 - 8 - Normally Closed - Left Hand Controls (All Pneumatic Control Types for Reverse Acting Thermostat)

*Electronic and DDC Units DO NOT Fail Open. "1" or "2" is used for Model Numbering Only. Electronic Units are shipped with the Damper in Closed Position. (Refer to the Controls Catalog AV-02 for additional operating information.)

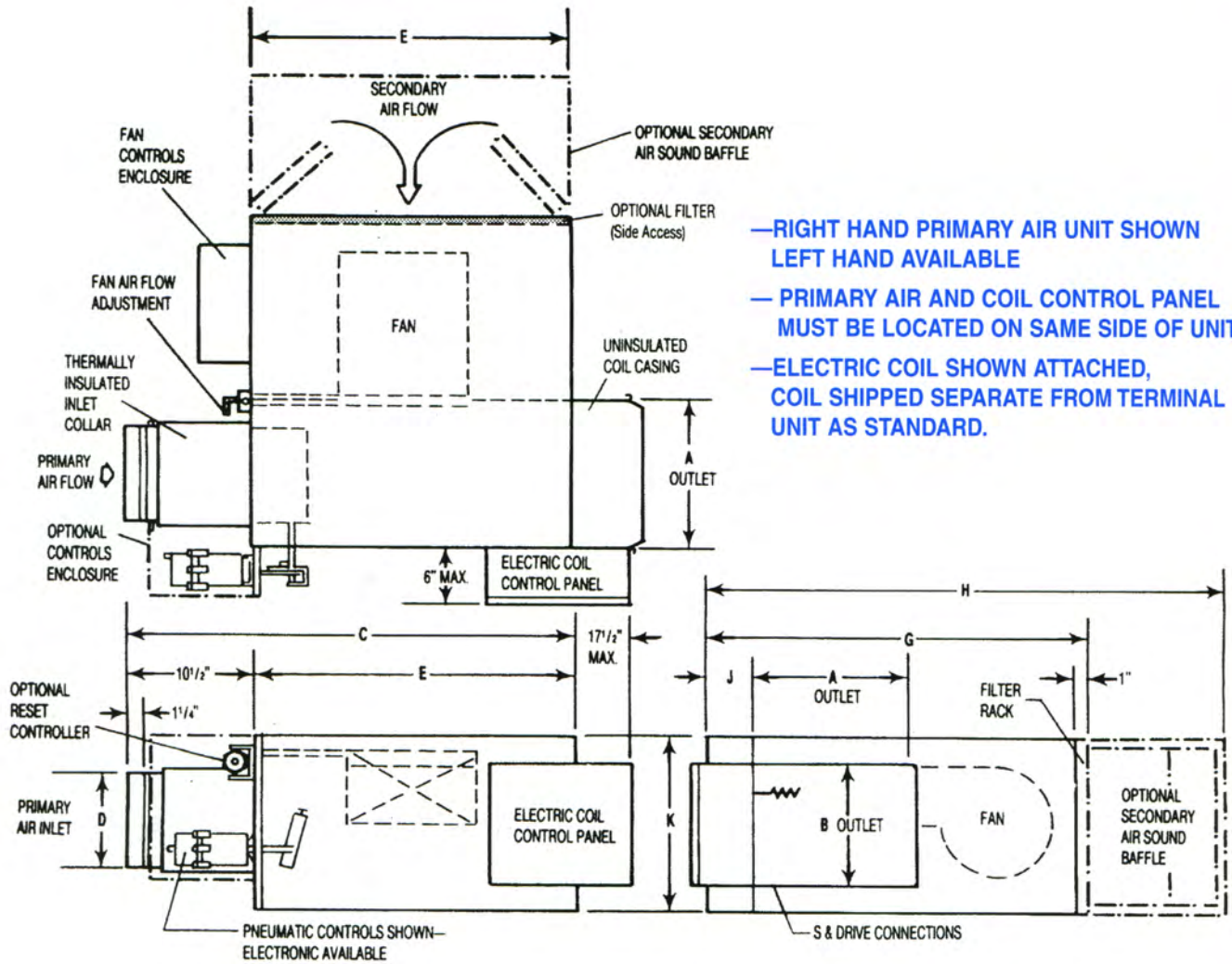

- RIGHT HAND PRIMARY AIR UNIT SHOWN LEFT HAND AVAILABLE
- PRIMARY AIR AND COIL CONTROL PANEL MUST BE LOCATED ON SAME SIDE OF UNIT.
- ELECTRIC COIL SHOWN ATTACHED, COIL SHIPPED SEPARATE FROM TERMINAL UNIT AS STANDARD.

DIMENSIONS LISTED IN INCHES													
Model	Unit Size	*Primary Nominal CFM	Secondary Nominal CFM @ .10" E.S.P.	Fan H. P.	S & Drive Outlet			Inlet H x W D	E	G	H	J	K
					A	B	C						
ASE	06	500	580	1/6	14	8	36-1/2	5-7/8	26	31-3/4	43-3/4	3-1/2	14
	07	700	580	1/6	14	8	36-1/2	6-7/8	26	31-3/4	43-3/4	3-1/2	14
	08	1000	770	1/5	14	8	36-1/2	7-7/8	26	31-3/4	43-3/4	3-1/2	14
	10	1500	1220	1/4	16	13	36-1/2	9-7/8	26	36-1/4	48-1/4	3-1/2	17-1/2
	12	2300	1575	1/2	16	13	36-1/2	11-7/8	26	36-1/4	48-1/4	3-1/2	17-1/2
	14	3100	2060	(2) 1/4	24	15-1/2	56-1/2	13-7/8	46	44-1/4	61-1/4	3-1/2	17-1/2
	16	4200	3020	(2) 1/2	24	15-1/2	56-1/2	15-7/8	46	44-1/4	61-1/4	3-1/2	17-1/2
ATE	08	1000	580	1/6	14	8	36-1/2	7-7/8	26	31-3/4	43-3/4	3-1/2	14
	10	1500	580	1/6	14	8	36-1/2	9-7/8	26	31-3/4	43-3/4	3-1/2	14
	12	2300	770	1/5	16	10-1/2	36-1/2	11-7/8	26	33-3/4	45-3/4	3-1/2	14
	14	3100	1220	1/4	24	15-1/2	36-1/2	13-7/8	26	44-1/4	56-1/4	3-1/2	17-1/2
	16	4200	1575	1/2	24	15-1/2	36-1/2	15-7/8	26	44-1/4	56-1/4	3-1/2	17-1/2
	18	5500	2310	(2) 1/4	32	15-1/2	56-1/2	15-7/8x17-7/8	46	52-7/8	69-7/8	4-1/8	17-1/2
	24	7300	3380	(2) 1/2	32	15-1/2	56-1/2	15-7/8x23-7/8	46	52-7/8	69-7/8	4-1/8	17-1/2

*Refer to "Primary Air Inlet Parameters" (page 6) when selecting MINIMUM and MAXIMUM CFM.