

IP Units (SI Metric on Reverse)

CARNES COMPANY, 448 S. Main St., P. O. Box 930040, Verona, WI. 53593-0040 Phone: 608/845-6411 Fax: 608/845-6470 carnes@carnes.com http://www.carnes.com

SQUARE

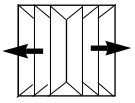

BLOW 20

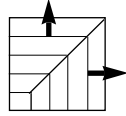

BLOW 25

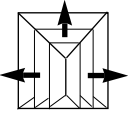

BLOW 30

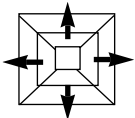

BLOW 40

RECTANGULAR

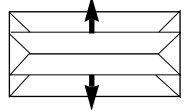

BLOW 21

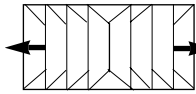

BLOW 22

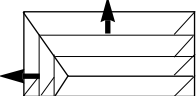

BLOW 26

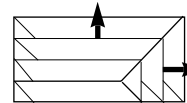

BLOW 27

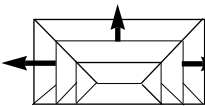

BLOW 31

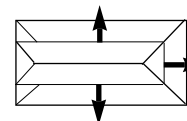

BLOW 32

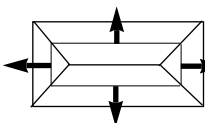

BLOW 41

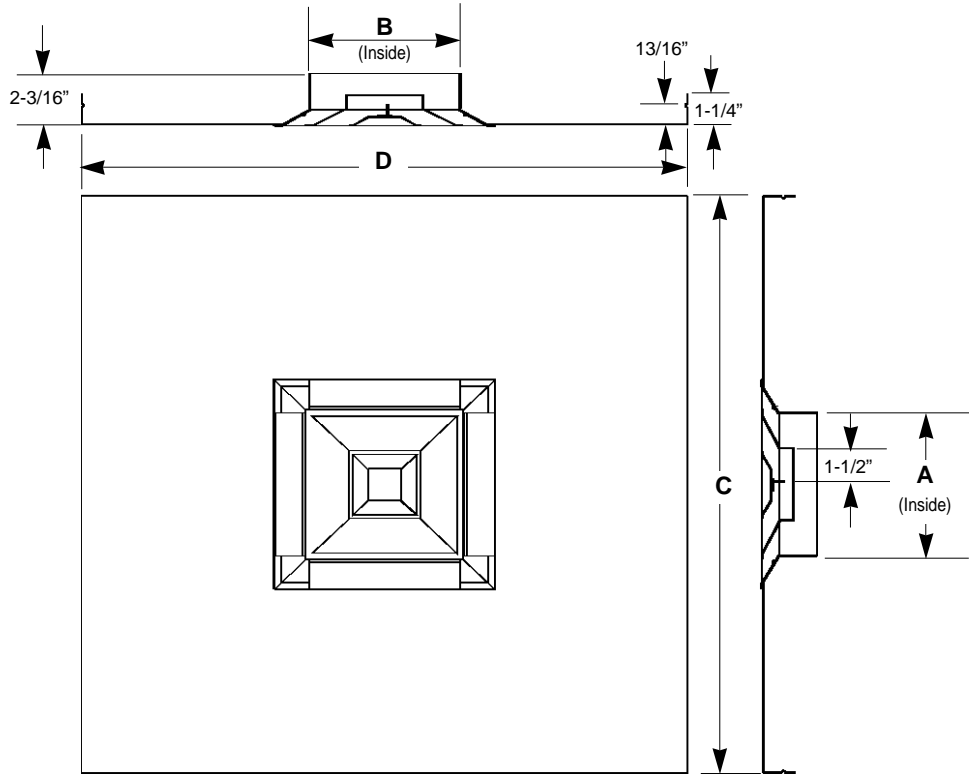

ADJUSTMENT

HORIZONTAL AIR FLOW

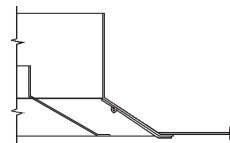

VERTICAL AIR FLOW

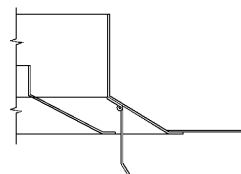

Remember that
Dimensions A & B are the
inside dimensions of the inlet.
The inlet is sized to fit over
the duct.

DIMENSIONS LISTED IN INCHES

Inlet Size	Panel	Panel	Panel
A x B	C x D	C x D	C x D
6 x 6	12 x 12	12 x 24	24 x 24
6 x 9	12 x 12	12 x 24	24 x 24
6 x 12	—	12 x 24	24 x 24
6 x 15	—	12 x 24	24 x 24
6 x 18	—	12 x 24	24 x 24
6 x 21	—	12 x 24	24 x 24
9 x 9	12 x 12	12 x 24	24 x 24
9 x 12	—	12 x 24	24 x 24
9 x 15	—	12 x 24	24 x 24
9 x 18	—	12 x 24	24 x 24
9 x 21	—	12 x 24	24 x 24
12 x 12	—	—	24 x 24
12 x 15	—	—	24 x 24
12 x 18	—	—	24 x 24
12 x 21	—	—	24 x 24
15 x 15	—	—	24 x 24
15 x 18	—	—	24 x 24
15 x 21	—	—	24 x 24
18 x 18	—	—	24 x 24
18 x 21	—	—	24 x 24
21 x 21	—	—	24 x 24

SI Metric Units (IP on Reverse)

CARNES COMPANY, 448 S. Main St., P. O. Box 930040, Verona, WI. 53593-0040 Phone: 608/845-6411 Fax: 608/845-6470 carnes@carnes.com http://www.carnes.com

SQUARE

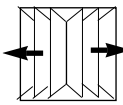

BLOW 20

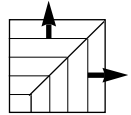

BLOW 25

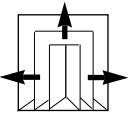

BLOW 30

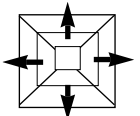

BLOW 40

RECTANGULAR

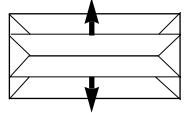

BLOW 21

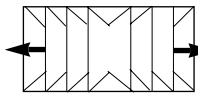

BLOW 22

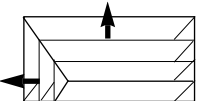

BLOW 26

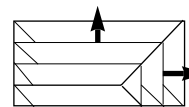

BLOW 27

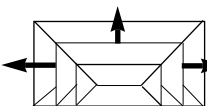

BLOW 31

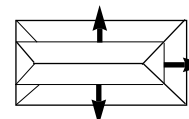

BLOW 32

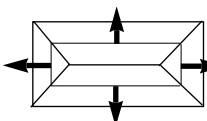

BLOW 41

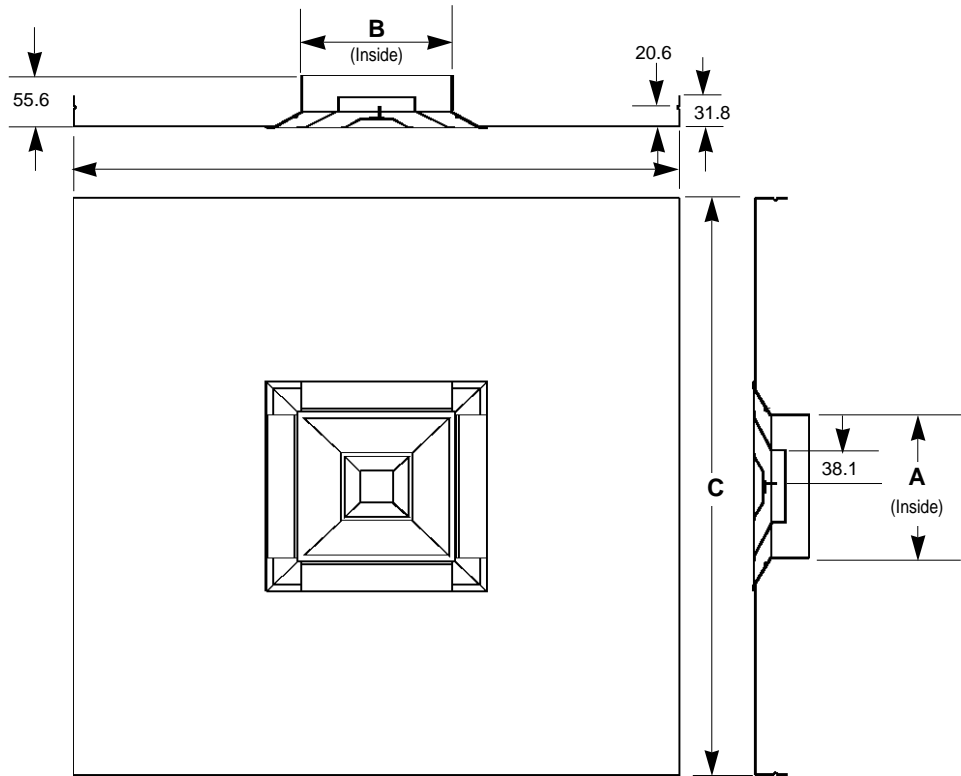

ADJUSTMENT

HORIZONTAL AIR FLOW

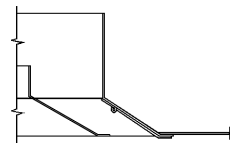

VERTICAL AIR FLOW

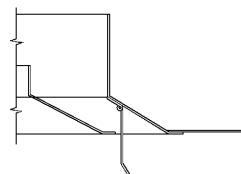

Remember that
Dimensions A & B are the
inside dimensions of the inlet.
The inlet is sized to fit over
the duct.

DIMENSIONS LISTED IN MILLIMETERS

Inlet Size	Panel	Panel	Panel
A x B	C x D	C x D	C x D
152 x 152	305 x 305	305 x 610	610 x 610
152 x 229	305 x 305	305 x 610	610 x 610
152 x 305	—	305 x 610	610 x 610
152 x 381	—	305 x 610	610 x 610
152 x 457	—	305 x 610	610 x 610
152 x 533	—	305 x 610	610 x 610
229 x 229	305 x 305	305 x 610	610 x 610
229 x 305	—	305 x 610	610 x 610
229 x 381	—	305 x 610	610 x 610
229 x 457	—	305 x 610	610 x 610
229 x 533	—	305 x 610	610 x 610
305 x 305	—	—	610 x 610
305 x 381	—	—	610 x 610
305 x 457	—	—	610 x 610
305 x 533	—	—	610 x 610
381 x 381	—	—	610 x 610
381 x 457	—	—	610 x 610
381 x 533	—	—	610 x 610
457 x 457	—	—	610 x 610
457 x 533	—	—	610 x 610
533 x 533	—	—	610 x 610