

CARNES®

Only Nature Moves and Conditions Air Better!

AIR DISTRIBUTION PRODUCTS: *Diffusers, Registers, Grilles and Air Terminal Units*

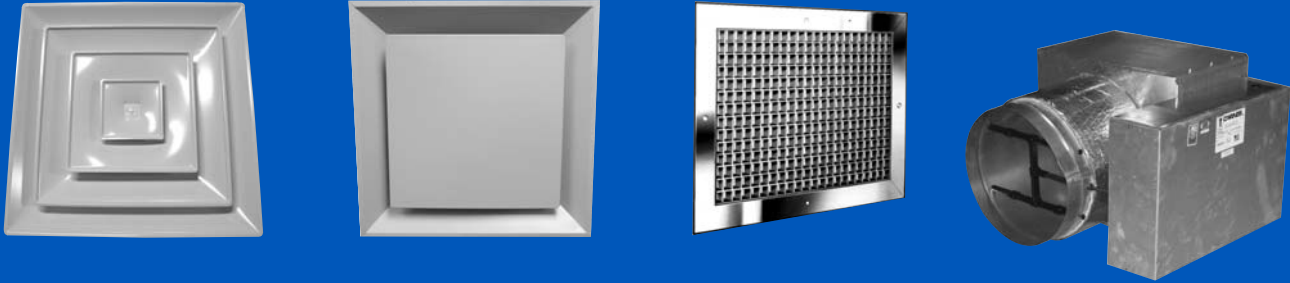

AIR MOVEMENT PRODUCTS: *Centrifugal Ventilators, Axial Fans and Non-Powered Ventilation*

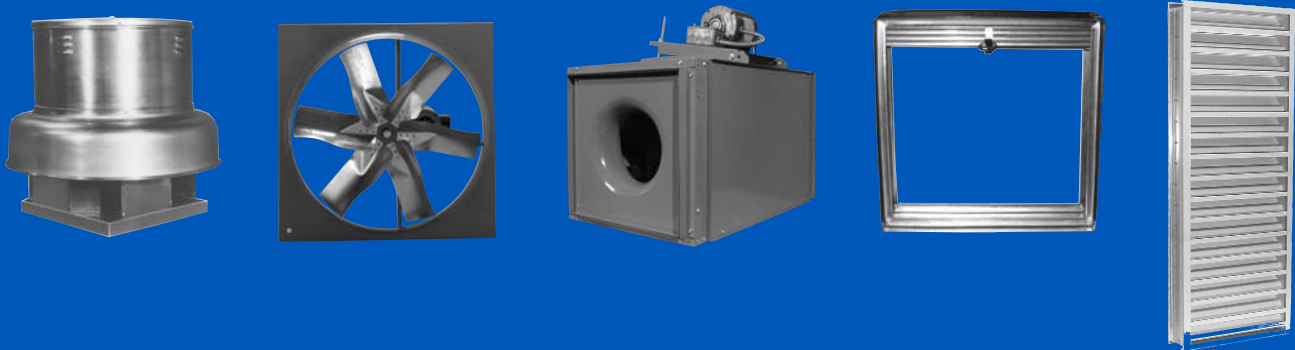

AIR CONDITIONING PRODUCTS: *Humidifiers, Energy Recovery Wheels, Ventilators, and Mini-Systems*

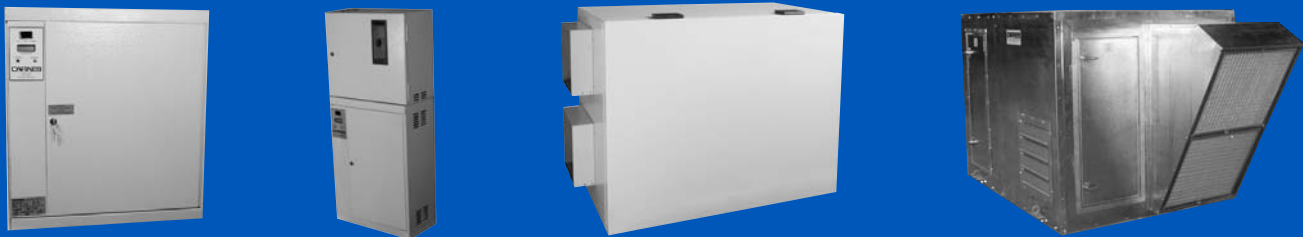

CARNES® COMPANY

Verona, WI 53593 • Phone: 608.845.6411 • Fax: 608.845.6504
www.carnes.com • carnes@carnes.com

D.O.

Catalog CG-09P
August 2011

A Fast Ship Program For Every Need.

Carnes offers many stock and quick build programs to meet your needs for fast shipment even on custom configured products. Carnes sales representatives lead the industry with online factory order capability, electronically expediting your order directly into the factory production stream.

**48
Hour**

48-Hour Stock Service

■ A Large selection of products with off-the-shelf shipment within 48 Hours.

- Steel Square Diffusers
- Steel Louvered Diffusers
- Aluminum Registers & Grilles
- Humidifier Accessories
- Steel Stamped Perforated Diffusers
- Aluminum Square Diffusers
- Equalizing Grids
- Steel Registers & Grilles
- Dampers - Round & Square
- Ceiling Fans & Accessories

EQS

Diffuser, Register & Grille Emergency Quick Ship

- Stamped Louvered Diffusers
- Stamped Perforated Diffusers
- Square & Rectangular Diffusers
- Linear Diffusers
- Spun Round Diffusers
- Registers & Grilles
- Auxiliary Frames
- Slot Diffusers
- Egg Crate

**5
Day**

**10
Day**

**Vent
Express**

Ventilator Express Service

**2
Day**

**5
Day**

**7
Day**

**10
Day**

■ Express service on hundreds of ventilators.
■ All express power vents have motor and drive mounted.

- Centrifugal Power Roof Ventilators
- Square In-line Duct Fans
- Centrifugal Wall Ventilators
- UL-762 Restaurant Exhausters
- Utility Sets - Backward Inclined/Forward Curved
- Sidewall Propeller Fans
- Centrifugal Filtered Supply Fans
- Ceiling & Cabinet Fans
- Gravity Intake/Exhaust Hoods
- Curbs, Dampers & Accessories

**VAV
Quickship**

Terminal Unit Fast Ship Service

**5
Day**

**10
Day**

■ Fast shipment of most popular unit types and a large selection of unit sizes.

- Single Duct With or Without Hot Water Reheat
- Pressure Dependent Controls
- Pressure Independent Controls
- Accessories

**Louver
Fast Ship**

Louver, Damper and Penthouse Fast Ship Service

**6
Day**

**10
Day**

■ Fast shipment of all louver and damper models.

**Fire
Damper
Fast Ship**

- Aluminum Drainable Blade Louvers
- Sight Proof Louvers
- Wind Driven Rain & Hurricane Louvers
- Volume Control Dampers

Table of Contents

Air Distribution Products

Diffusers	4
Registers and Grilles	8
VAV Terminal Units	10

Air Movement Products

Fans and Ventilators	12
Louvers and Penthouses	18
Dampers	18

Air Conditioning Products

Energy Recovery Products	20
Humidifiers	21

Software for Equipment Selection and Reference

FAN-C-LECT™

The easy to use software program for the selection of power roof ventilators, propeller fans and ceiling fans. The program will generate performance and BHP curves and dimensional drawings. Requires Windows™.

VAV-C-LECT™

This terminal unit selection program selects throttling and fan powered terminal units complete with integrated water and electric coil performance data. Equipment selection and performance data is presented in a user defined page format. Requires Windows™.

ENERGY-C-LECT™

The energy recovery selection program enables quick and simple selections of Energy Recovery Wheel Cassettes, Energy Recovery Ventilators and Energy MiniSystems with or without heating and/or cooling coil(s). Complete submittal information is generated for each selection. Requires Windows™.

HUMIDIFIER-C-LECT™

Humidifier load calculations using the programs are extremely easy by simply entering design conditions or room dimensions. The humidification load is calculated and the program then leads the user through a step-by-step selection of the appropriate humidifier. Requires Windows™.

All Carnes selection software supports IP and SI (metric) units of measure.

Air Distribution Products

48
Hour

EQS

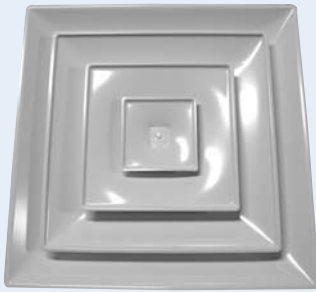

Model SFTB

STAMPED LOUVERED DIFFUSERS

Carnes round neck square diffusers combine the unobtrusive appearance of square diffusers with optimum performance of round diffusers. The smooth lines created by stamping process eliminates the miter lines and creates a modern, aesthetically pleasing diffuser. Models available for fixed horizontal or adjustable horizontal or vertical air patterns. Models also available with solid metal plaque face. Round necks are standard and designed primarily for flex duct connection. Collar height is a full 1-1/4" for easy connection taping. Round neck diffusers are available in eight sizes and can be selected for either surface mounting or T-bar lay-in. Models are available in cold roll steel or aluminum construction.

PLAQUE DIFFUSER

This offers an architecturally pleasing alternative to the standard stamped louvered diffuser. The flat surface of the plaque face blends better with suspended ceiling tiles, and the design delivers horizontal flow at low air flows, making it very well suited for VAV system designs. Round neck duct connections make this easy to install with flex duct.

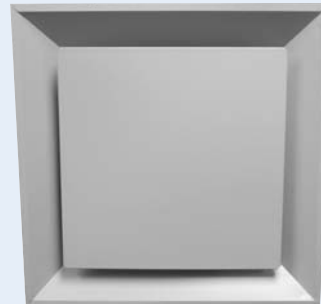

Model SFPA

48
Hour

EQS

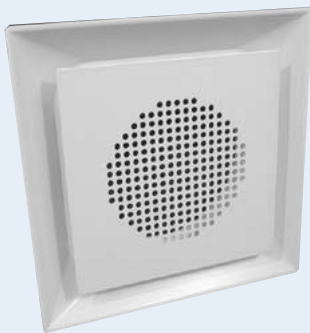

Model SFHA

PLAQUE DIFFUSER WITH PERFORATED FACE

Best suited for applications where large volume spaces combine with high ceilings and low sound level requirements, this diffuser is designed to deliver 50% of the airflow straight down, and 50% horizontally. It is well suited for movie theaters and churches, where seasonal adjustment is not practical, and low sound levels are critical.

EXTRUDED ALUMINUM DIFFUSERS

Extruded aluminum square and rectangular ceiling diffusers feature all-aluminum construction giving the unit a sharp, clean appearance. The diffusers are available in 1-way, 2-way, 2-way corner, 3-way and 4-way patterns. Great flexibility with three different frame styles. The ceiling diffusers are available with square, rectangular or round necks.

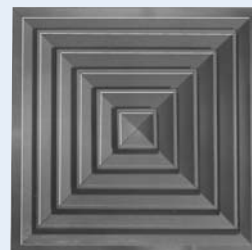

Model SAFM

SQUARE LOUVERED/PLAQUE DIFFUSER

This offers an architecturally pleasing alternative to the standard diffuser. The flat surface of the plaque face blends better with suspended ceiling tiles, and the louvered design around the perimeter delivers horizontal flow at low air flows, making it very well suited for VAV systems designs. It is available in a range of inlet sizes, and from 1 to 4 slots, so as to accommodate a range of air flows. It is designed to lay into 24" x 24" T-bar ceilings, and round neck duct connections make this easy to install with flex duct.

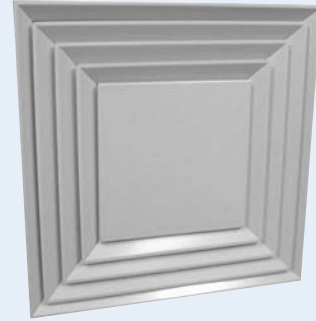

Model SKPB

48
Hour

EQS

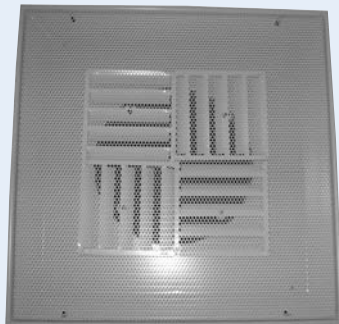

Model SPAB

STAMPED PERFORATED DIFFUSERS ROUND AND SQUARE NECK

Carnes stamped perforated diffusers are available with round or square inlets. By simple on-the-job adjustment, 1-way, 2-way, 2-way corner, 3-way or 4-way air patterns can be attained. Matching supply and return models are available for plaster, T-bar, Fineline® or spline ceilings. Round neck models are available in sizes 5" to 16" and square neck models in sizes 6 x 6 to 22 x 22. Models are also available with adjustable curved vane pattern controls. These models are available in 1-way, 2-way, 2-way corner, 3-way or 4-way air patterns with round or square inlets. Models are available in cold roll steel or aluminum construction.

FABRICATED SQUARE AND RECTANGULAR DIFFUSERS

These square and rectangular diffusers are available in 1-way, 2-way, 2-way corner, 3-way and 4-way blow patterns. Four frame styles provide design flexibility. Adjustable models are available that provide horizontal, vertical or intermediate patterns. Models are available in steel or formed aluminum construction.



48
Hour

EQS

Model SKSA

10
Day

EQS



Model SMFB

MODULAR CORE DIFFUSER

Carnes SM Series modular core diffusers are extremely versatile and will meet most job applications. Models are available in six different ceiling frame styles, in steel or formed aluminum construction. Each unit is equipped with four 1-way blow cores that are easily removed and rotated to change the blow pattern. The SM series is available in square neck sizes from 6 x 6 through 24 x 24. All square sizes are available with optional round neck adapters.

Air Distribution Products

48
Hour



Model SSEA

ROUND DIFFUSERS

Round ceiling diffusers are available for a variety of applications. This line includes units that are completely adjustable, semi-adjustable or non-adjustable. Adjustable units are ideal where horizontal and vertical air patterns are desired. The three position adjustable unit provides a horizontal, vertical or intermediate pattern while the non-adjustable units are for horizontal patterns.

DIFFUSER AUXILIARY FRAME

The Carnes diffuser auxiliary frame is an accessory that enables a T-bar lay-in or slot diffuser to mount to a hard ceiling. It mounts to framing above the ceiling and provides a surface to lay a T-bar diffuser into. This enables the use of a wide range of diffusers in a hard ceiling. It also creates access to the ceiling plenum to service utilities without the need to add a separate access panel. The wide flange allows for the occasional error in cutting the ceiling opening for the frame. Available in steel or extruded aluminum.

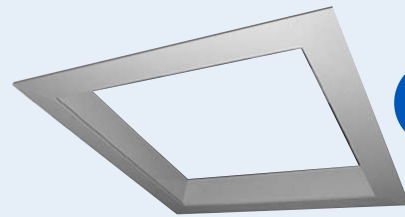

48
Hour

Model KXFAA

EQS

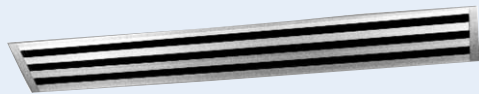

Model CHDB

CHANNELAIRE™ DIFFUSERS

Carnes Channelaire™ is an extruded aluminum linear diffuser for ceiling installation. It uses an adjustable vane in each slot to control the direction of air discharge, either parallel with or perpendicular to its surface. It is available in one to eight slots. Available slot widths are 1/2", 3/4" or 1". The unit can be provided for continuous installation from wall-to-wall or it can be provided as individual diffusers having lengths from 1 to 6 feet.

The Channelaire™ unit offers the flexibility of use as a supply or return unit as well as a blank-off section. Its design makes it adaptable for use with T-bar, spline type tile, grid type suspension or plaster ceilings. Mitered corners are available for perimeter installation.

ARMSTRONG® TECHZONE™ COMPATIBLE LINEAR DIFFUSERS

Armstrong® TechZone™ compatible linear diffusers are specifically designed to be used with Armstrong® TechZone™ ceilings. The TechZone™ series is available for lay-in with 1-4 slots and available for tegular applications in 1-3 slots.

Slots are 3/4" and are available in the following lengths: 24", 30", 36", 48", 60" and 72".

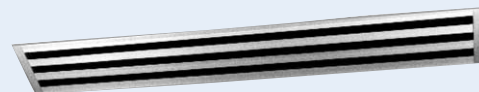

Model DTCA

EQS

*Dependance
on quantity.
Contact factory.*

ADJUSTABLE PATTERN T-BAR SLOT DIFFUSERS

Carnes DA Series adjustable pattern T-bar slot diffusers are compatible with most T-bar ceiling types. Models are also available for Donn® Fineline® ceilings. They are available in 3/4", 1" or 1-1/2" wide slots in one, two, three, or four slot models. The available unit lengths are 24", 30", 36", 48" and 60". Models are available for both supply and return applications. Each supply model has an individually adjustable pattern control in each slot for horizontal or vertical air pattern. Both supply and return models are available with insulated or uninsulated plenums. The insulation conforms to UL 181 and HFGA 90A requirements. Model DAFA, which carries a UL three hour fire classification, is available in one or two slot models in 24" or 48" lengths.

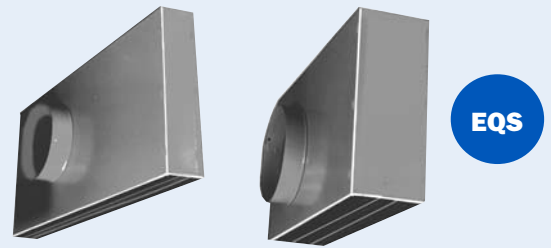

Model DASC/DASD



Model DFRB-Return

Model DFRB-Return

FIXED PATTERN T-BAR SLOT DIFFUSERS

Plenum slot diffusers are an integral part of the variable air volume system. They blend in harmoniously with ceiling architecture while providing extraordinary air distribution qualities. These diffusers reduce the effect of down draft at low air quantities and discharge a remarkably uniform air flow. Plenum slot diffusers are especially valuable where there are high throttling ratios, at low CFM levels, and with cool supply air to assure proper induction and mixing with room air. They are manufactured from rust-resistant galvanized steel. Models are available for supply, return, supply with down blow feature and supply with return combination.

INDUSTRIAL ROUND DIFFUSER

Used in large volume spaces with high ceilings, this provides easy and quick adjustment between horizontal and vertical discharge of the supply air stream. A simple 45° twist of the handle flips from one setting to the other. Designed to handle large air volumes, it is well suited for animal labs and other industrial settings.



Model SSDB

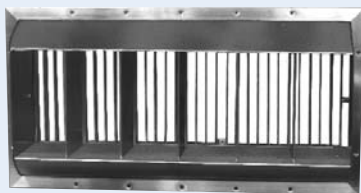

Model RAWA

DRUM LOUVERS

Carnes drum louvers are designed to be used in applications requiring long throws with minimum duct work. The deflecting blades can be adjusted to increase or decrease air diffusion. The drum may be rotated 300 up or down from the centerline, providing a full 600 angular adjustment. The drum louvers are extruded aluminum construction and are available with or without an opposed blade balancing damper.

Air Distribution Products



Model RSHAH

HEAVY DUTY RETURN REGISTERS AND GRILLES

Sturdicore™ registers and grilles are specifically designed for areas where exceptional strength is required, i.e., gymnasiums, hospital psychopathic wards, etc. The 1/8" thick face bars are rounded to decrease the possibility of injury and are available in 0 and 40 degree settings. The registers are equipped with opposed blade dampers that are key-operated through the face. The heavy duty frame is reinforced at the corners for added strength. Mullions are recessed and on 6 inch centers. The grilles are all welded steel construction and come in single panel sizes up to 72 inches wide (with bars mounted horizontal) and 48 inches high.

EGGCRATE RETURN

The all-aluminum eggcrate return grilles feature extruded aluminum frames and fabricated aluminum louvers. There are three configurations of louvers available: 1/2" x 1/2" x 1/2" deep, 1" x 1" x 1" deep and 1/2" x 1/2" x 1" deep. Registers are available with either an extruded aluminum or steel opposed blade damper.

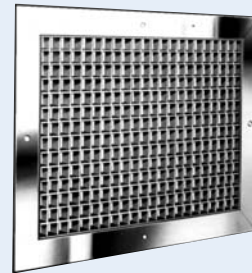

Model RAPAF

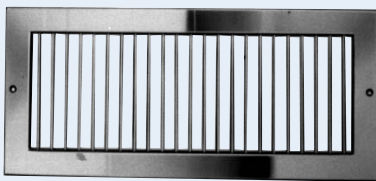

Model RSSBV

FORMED STEEL, ALUMINUM AND STAINLESS STEEL SUPPLY AND RETURNS

Supply units are single or double deflection adjustable registers and grilles. The attractive supply units provide effective directional air stream control in one or two directions for single deflection or up to four directions for double deflection units. Return air registers and grilles are styled to match the supply units. Door and partition grilles are also available.

Formed Steel - EQS 5 & 10 Day
Stainless Steel - EQS 10 Day

EXTRUDED ALUMINUM SUPPLY AND RETURNS

The extruded aluminum register and grille products cover a broad line. Constructed from natural anodized aluminum extrusions, these registers and grilles are available in adjustable single and double deflection supply, or curved blade supply in 1-way, 2-way, 3-way and 4-way directional patterns. Return grilles and registers are styled to match the supply units. Extruded products have flat borders with clean sharp lines with mechanically joined corners for extra strength and minimum hairline mitered joint. Extruded aluminum door grilles are available with a channel frame, single flange frame or double flanged frame.

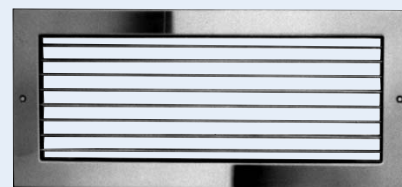

Model RASMH

**LINEAR BAR GRILLES CURTAINAIRE™
AND TRIMAIRE™**

Curtainaire™ - Carnes extruded aluminum Curtainaire™ is an attractive, beautifully finished, linear type pencil proof grille. It is ideal for sill applications, efficient for high side walls and practical for use as ceiling outlets. Units are available with 3/4" or 1" borders and 0° or 15° blade deflection, sized in 2" to 24" widths in 1/2" increments and up to 72" lengths in one piece with 1/4" blades on 1/2" centers.

Trimaire™ - Carnes extruded aluminum Trimaire™ is an exquisite unit that will contribute to the appearance of any modern building interior. Available in width sizes from 2" to 24" in 1/2" increments. Trimaire™ flexibility also includes two basic surfaces-- 1/8" blades on 1/4" centers and 1/8" blades on 1/2" centers. Both are available in 0° and 15° deflection.

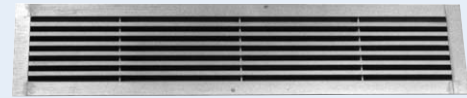

Model CCGBG

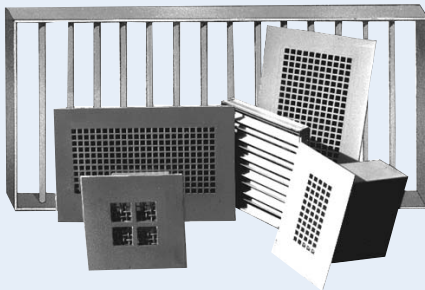

SECURITY REGISTERS, GRILLES AND DIFFUSERS

Carnes offers a complete line of security products. It consists of minimum, medium and maximum security devices. Security grilles and diffusers are available with or without volume control dampers. Carnes security products meet or exceed ASTM standards. Sizes range from 4" x 4" to 48" x 48".

Many are done as specials. Contact factory for unique requirements.

INDUSTRIAL SUPPLY GRILLES AND REGISTERS

Designed to accommodate large air volumes and high velocities, Carnes Industrial R&G are available in both single and double deflection models. Blades are heavy duty extruded aluminum, and are individually bolted to the mounting frames for ruggedness. The specifier has a choice of 1-1/2", 2" or 3" blades on the same centers.

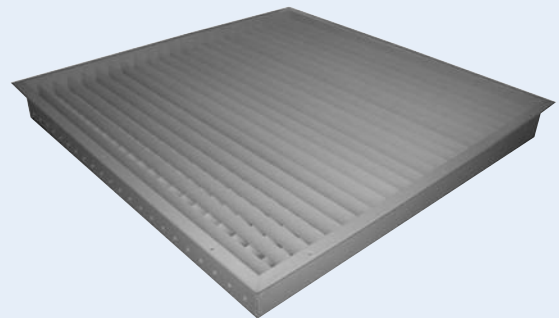

Model RCJA

Air Distribution Products

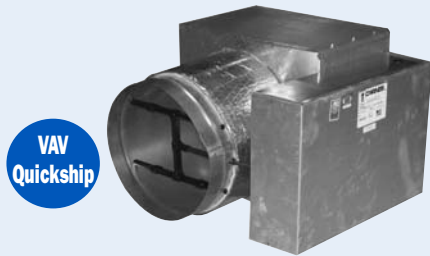

Model AV

EXTERNALLY POWERED THROTTLING UNIT

Carnes standard air terminals are designed to accurately control airflow and temperature in today's VAV systems. These units are built to provide very low pressure drops and sound levels which are certified by AHRI. All units are thermally lined with insulation meeting UL Test 181 and NFPA 90A requirements. Control options include pneumatic, electric, electronic and factory mounted digital. Optional hot water or electric reheat is available. Air capacity range from 0 to 7300 CFM.

ROUND-TO-ROUND RETROFIT

This duct mounted retrofit unit automatically controls the air volume in high velocity air streams. The unit is installed between duct sections and will accommodate circular duct work at the inlet and discharge. The volume control unit also reduces high velocities and pressures to low velocity values. Eight unit sizes are available for duct mounting, with air capacities ranging from 0 to 4200 CFM. This design is also available with stainless steel construction.



Model ARR

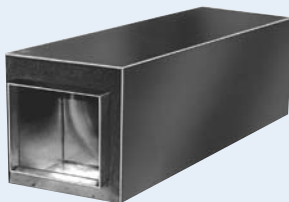

Model AXPA
Patent No. 5,663,535

CLEAN AIR SILENCER

The Carnes model AXPA clean air silencer has been designed and engineered to reduce discharge sound levels of air terminal units. The model AXPA is a "reactive type" silencer which attenuates discharge noise levels from air terminals and other devices without the use of sound absorptive materials such as fiberglass, mineral wool, etc. This eliminates indoor air quality concerns when using the model AXPA silencer.

BY-PASS UNIT

Carnes VAV by-pass units provide variable air volumes to individual zones while by-passing the unneeded air to the ceiling plenum for recirculation. Although zone air volumes in small buildings may vary greatly, the cost of central fan controls many times cannot be justified. Zone variable air volumes are realized with the by-pass unit while the supply fan delivers a constant CFM. Zone thermostats directly controlling the by-pass damper assures that only the air that is needed is delivered to the zones. Downstream duct work pressure losses can be matched by adjusting an integral balancing damper. Hot water reheat available.

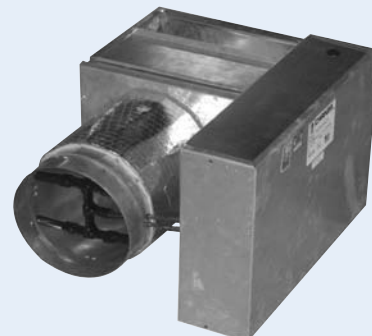

Model AB

DUAL DUCT VAV UNIT

Carnes dual duct VAV unit contains two low pressure drop throttling valves. Hot and cold duct valves are independently controlled. Pressure independent reset constant volume controllers accurately control the hot and cold duct air flows to keep energy wasteful mixing to a minimum. Return air ducted to the hot inlet allows significant energy savings when outside air is ducted to the cold air supply. Hot and cold airstream mixing assures a constant temperature at the discharge of the unit. A wide variety of available control sequences makes the Carnes dual duct VAV adaptable to most energy saving system designs.

Model ADCD is used for constant volume applications. Model ADCC is used for variable volume hot and cold duct applications.

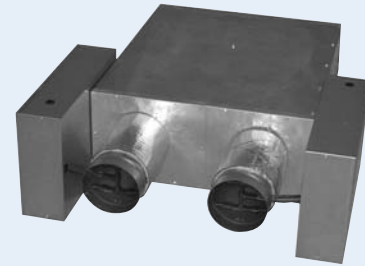

Model ADCC and ADCD

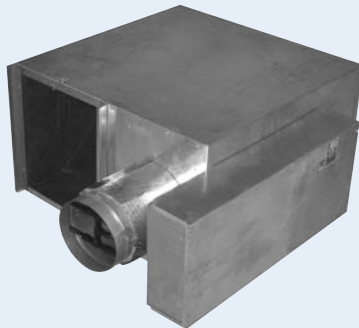

Model AC

CONSTANT VOLUME FAN TERMINAL UNIT

The Carnes constant volume fan terminal unit provides constant volume to the space while retaining the advantages of a variable air volume system. The primary air control assembly operates in the same manner as a standard throttling control valve when cooling loads are high. As cooling loads diminish, an integral blower induces warm ceiling plenum air to maintain constant volume to the zone. Optional hot water or electric reheat available. Also available is a comprehensive line of low profile, underfloor and quiet design units. All constant volume fan terminal units are available with an ETL listing.

INTERMITTENT VOLUME FAN TERMINAL UNIT

The Carnes intermittent volume fan terminal unit allows the use of recirculated air when true VAV cannot fulfill heating requirements. The intermittent fan terminal unit operates in the same manner as the throttling unit when cooling loads are high. As cooling loads diminish, an integral blower is energized and supplies recirculated air to the zone. Intermittent fan terminal units can be used to provide heat to perimeter zones with the central system fan turned off. A wide variety of control sequences makes the fan terminal unit compatible with most energy efficient system designs. Optional hot water or electric reheat is available. Also available in a low profile design. All intermittent volume fan terminal units are available with an ETL listing.

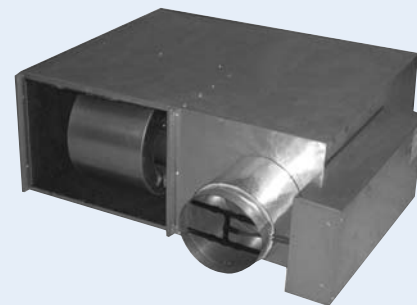

Model AS

Vent
Express



Models VEDK/VEBK

CENTRIFUGAL POWER ROOF VENTILATORS

Carnes centrifugal power roof ventilators comprise one of the most complete lines available. The unique design of the Patented (#4890547) Diffuser Assembly (sizes 06 - 24), the innovative wheel and precision matched venturi enable the K-Series fans to reach high static pressures. Birdscreen, thermal overload (single phase motors only), conduit chase and adjustable drives are standard features on Carnes ventilators. Roof ventilators are available in direct drive or belt drive arrangements. Roof curbs and backdraft dampers can be furnished as accessories. Model VEDK Direct Drive, six sizes 06-18; capacities from 70 to 4,000 CFM. Model VEBK Belt Drive, thirteen sizes 06-54; capacities from 70 to 39,000 CFM.

Units are AMCA certified for air and sound and are available with UL or CSA listings.

CENTRIFUGAL POWER WALL VENTILATORS

Carnes centrifugal power wall ventilators are available in direct drive or belt drive units and are designed to compliment the configurations of the Carnes roof mounted K-Series ventilators.

The spun and shaped aluminum housing, wall mounting flange, birdscreen and safety disconnect are standard items. Carnes centrifugal fan units feature backwardly inclined wheel blades with self-limiting power characteristics. The wall ventilators have the motor mounted out of the exhaust air stream, positive ventilation of the motor compartment and the motor mounting frame grounded. Model VWDK Direct Drive, sizes 06 to 18; capacities 150 to 4,000 CFM. Model VWBK Belt Drive, sizes 06-24; capacities 225 to 9,000 CFM.

Units are AMCA certified for air and sound and are available with UL or CSA listings.

Also available with UL 762 construction for kitchen applications (model VRBK).

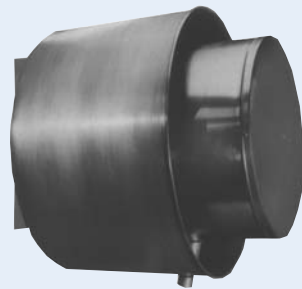

Vent
Express

Models VWDK/VWBK/VRBK

Vent
Express



Models VUDK/VUBK/VRBK

UPBLAST ROOF VENTILATORS

Carnes upblast roof ventilators are offered as both belt and direct drive units. The housing is spun and shaped aluminum. Upblast units are used when it is desirable to keep the exhausted contaminants away from the roof area and avoid recirculation through the building intakes. The fan wheel is dynamically balanced and each unit is test run after assembly. Motor, bearings and drives are mounted out of the air stream insuring longer trouble-free operation. Model VUDK Direct Drive, sizes 06 to 18; capacities to 4,000 CFM. Model VUBK Belt Drive, sizes 06 to 48; capacities to 31,000 CFM.

Units are AMCA certified for air and sound and are available with UL or CSA listings.

Also available with UL 762 construction for kitchen applications (Model VRBK).

CEILING FANS

Carnes VCDD & VCDK ceiling fans are designed to provide effective room ventilation at some of the lowest noise levels in the industry. Units are available in a standard ceiling fan configuration with an attractive plastic or metal grille, and a dedicated in-line model with two duct connections and an access panel. Units are constructed of galvanized steel, with plastic or metal blower wheels. Fourteen speed controllable sizes are available with capacities from 30 to 3500 CFM.

Units are AMCA certified for air and sound and bear UL and CSA listings.

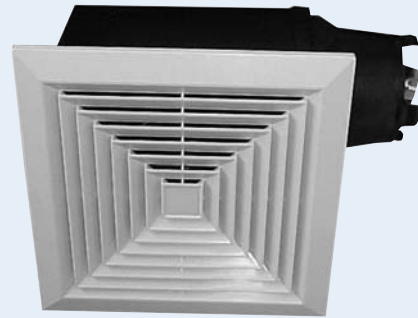

**48
Hour**

Models VCDD & VCDK

**48
Hour**



Models VIDK/VIBK

SQUARE IN-LINE CENTRIFUGAL FANS

The compact in-line duct fans feature backwardly-inclined wheels and deep venturi inlet to provide superior aerodynamic performance and quiet operation. The units are available in six direct drive sizes, model VIDK 06-18 and ten belt drive sizes, model VIBK 06-36 and provide maximum air handling capacity from the minimum amount of space. Removable panels provide complete access to interior components to provide serviceability without removal from the ducts. Units can be floor mounted or hung from wall or ceiling, and mounted at any angle. Capacities range from 65 to 21,000 CFM and static pressure to 2-1/2 inches w.g.

Units are AMCA certified for air and sound and are available with UL or CSA listings.

UTILITY SETS - BELT DRIVE

Carnes offers both forward curved and backward inclined wheel construction of utility sets. The Carnes model VFB, forward curved, is available in sizes 12 through 36 with capacities to 29,000 CFM and pressures up to 5 inches w.g. The backward inclined, non-overloading model VBB is designed to perform at up to 8" W. G. static pressure. Sizes 12 to 36 are available with capacities up to 29,000 CFM.

Units are AMCA certified for air performance.



**Vent
Express**

Models VFB and VBB

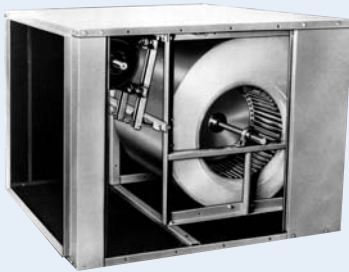

Models VDBA/VGBA

DUCT BLOWERS

The Carnes models VDBA and VGBA duct blowers are economical and efficient all purpose in-line belt driven duct blowers. These fans utilize quiet forward curve blowers which operate at low speed. The motors receive the cooling benefit of being in the airstream for increased motor life and access panels are provided for convenient servicing from two sides. Filter sections with drawer type filter racks are available as an optional accessory. Model VDBA is designed for use indoors, and model VGBA is designed with a weather proof insulated housing for both indoor and outdoor use. Thirteen sizes are available with capacities from 300 to 24,000 CFM and static pressures up to 2-1/2 inches w.g.

Units are AMCA certified for air performance.

TUBEAXIAL FANS

The Carnes tubeaxial fans are ideal for supplying or exhausting air at relatively low static pressures. These fans can be mounted from the ceiling, off the floor or within a duct. The belt driven model LIBA is available in five sizes with performance of 4,700 CFM to over 38,000 CFM at 0" static pressure. The direct drive LIDA is available in seven sizes, 12" to 36", with air performance ranging from 770 to 24,000 CFM at 0 inch static pressure.

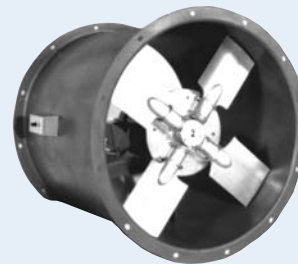

Models LIDA/LIBA



Vent
Express

Models VSBB and VHBB

CENTRIFUGAL FILTERED SUPPLY VENTILATORS

The Carnes model VSBB filtered supply units are offered as belt driven units. The galvanized steel exterior houses 1" permanent aluminum filters and a double width forward curved blower. This roof mounted unit was designed to supply makeup air for various applications. Six sizes ranging from 08-20, deliver capacities from 500 to 13,000 CFM and static pressure up to 2 inches w.g.

The model VHBB incorporates an attractive aluminum louvered hood with mitered and welded corners.

Units are AMCA certified for air and sound and are available with UL or CSA listings.

**LOUVERED LOW SILHOUETTE
CENTRIFUGAL VENTILATOR**

The model VL features an attractive low silhouette louvered ventilator that will compliment any building. This series features extruded aluminum louvers with mitered and welded corners.

Design flexibility is increased by the availability of both belt drive model VLBK sizes 06 through 54, capacities from 120 to 38,000 CFM and direct drive model VLDK sizes 06 through 18, capacities from 120 to 4,415 CFM.

Units are AMCA certified for air and sound and are available with UL or CSA listings.

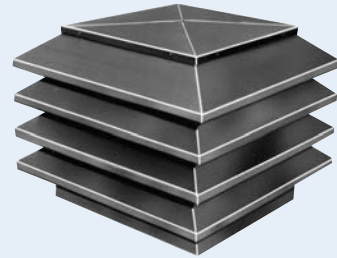

Models VLDK/VLBK

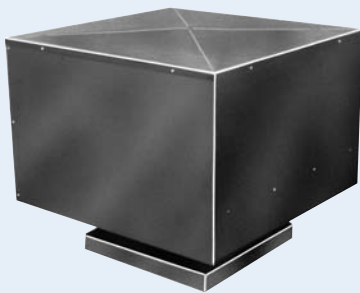

Models VTDK/VTBK

**LINEAR LOW SILHOUETTE
CENTRIFUGAL VENTILATOR**

The linear appearance of the model VT provides a clean, low profile that blends attractively with modern architectural designs. The model VTBK is belt driven while the model VTDK is direct driven. Both are available with either aluminum or galvanized steel hoods. The integral curb cap and venturi is always constructed of corrosion resistant aluminum. Sizes 06 through 54 (belt drive) capacities from 120 to 38,000 CFM and 06 through 18 (direct drive) capacities from 120 to 4,415 CFM.

Units are AMCA certified for air and sound and are available with UL or CSA listings.

LOW SILHOUETTE AXIAL ROOF VENTILATORS

Carnes line of low silhouette axial power roof ventilators are ideal for installations requiring high performance and a clean, modern appearance.

These units are available for exhaust, supply or filtered supply applications. All units are available in either belt or direct drive configuration. Capacities of the exhaust units range from 5,000 CFM to 50,000 CFM in sizes 24" to 60". Supply units, sizes 24" to 60", have capacities of 6,000 CFM to 63,000 CFM.

Filtered supply units, sizes 24" to 48", have capacities of 6,000 CFM to 45,000 CFM.



Models LTBA/LTDA, LGBA/LGDA, LFBA/LFDA



Models LUBA/LUDA

UPBLAST AXIAL ROOF VENTILATORS

Carnes model LUBA, belt drive and LUDA, direct drive upblast exhausters provide efficient discharge of contaminated air high above the roof for effective dispersion into the atmosphere. Unitized fan curb, heavy gauge windband braced against cross winds, positive closing butterfly dampers and watertight rain channels insure effective weather protection. These units are available in blade diameters of 24" through 72" with capacity to 85,000 CFM.

Air Movement Products

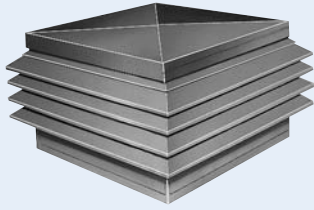

Model GL

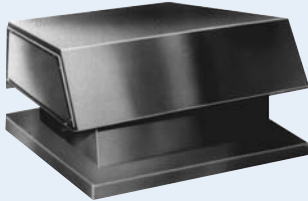

Models GE/GI

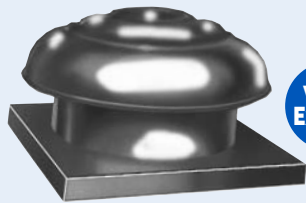

Model GS

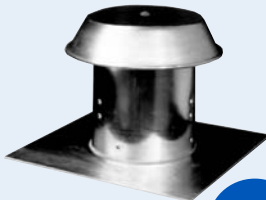

Model VX



Carnes Non-Powered Ventilators

Carnes offers a complete line of non-powered ventilators specifically designed to match and compliment our powered ventilators. Carnes manufactures a variety of models in both aluminum and galvanized construction. Optional finishes and screens are also available.

SERIES GL: LOUVERED INTAKE/EXHAUST

The series GL, louvered penthouse, features a low profile that blends in well with a wide variety of architectural designs. This model comes completely assembled and features aluminum construction with fully welded mitered corners. These units are available in many sizes and are suitable for either exhaust or intake applications.

SERIES GE/GI: LOW SILHOUETTE EXHAUST/INTAKE

This attractive low silhouette design is available in both exhaust (GE) and intake (GI) models for either application. The GE model is typically used for exhaust applications. The GI models feature increased hood area that allows lower inlet velocities to reduce moisture entrainment for intake applications. These units are available in both aluminum and galvanized steel.

SERIES GS: SPUN ALUMINUM

The GS series provides low silhouette design in an attractive spun aluminum. These units are suitable for either exhaust or intake applications. The GS features heavy gauge aluminum construction that will provide years of attractive service.

SERIES VX: SPUN ALUMINUM ROOF CAP

Carnes Series VX aluminum low silhouette roof caps offer an attractive spun design at an economical cost. These units feature a spun roof cap and an integral stamped birdscreen. VX units are available with a curb cap or a self flashing base.

Propeller Wall Fans - Belt Drive

Carnes belt drive propeller wall fans provide efficient and cost effective air movement. Available in both supply and exhaust configurations, separate designs optimize cost and performance in any application.

LWBK/LMBK

This model is ideal where performance and economy are required. This version offers durable die-formed galvanized steel blades, which can deliver up to 32,000 CFM and are available in sizes 20" through 48".

Units are available with UL or CSA Listings.
Units are AMCA Certified for Air and Sound (LW/LM only).

LRBK/LNBK

For applications requiring greater air movement at higher static pressure and quiet operation, specify these models. Available from 24" to 72" these units utilize extruded aluminum adjustable pitch, air foil blades with capacities to over 100,000 CFM and up to 1" static pressure.



Model LWBK

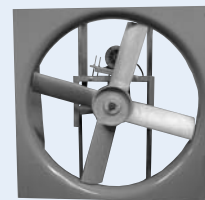

Model LRBK

PROPELLER WALL FANS - DIRECT DRIVE

Direct driven wall fans have the advantage of offering reduced maintenance and operating costs. These models are offered in both supply and exhaust configurations.

LYDK/LZDK

These economical fans provide premium air performance and quiet operation with aluminum blades. Sizes range from 10" to 20" with capacities up to 5,000 CFM and up to 0.75 w.g.

LJDB/LKDB

Developed for general ventilation applications, these fans can provide advantages in first cost and low noise. They are available in five sizes 10" through 30", with capacities in excess of 12,000 CFM.

LRDA/LNDA

Models LR/LN are available in sizes 24" through 72". These units provide the advantages of direct drive, utilize adjustable pitch extruded air foil blades and offer capacities to 56,000 CFM and up to 1" w.g.

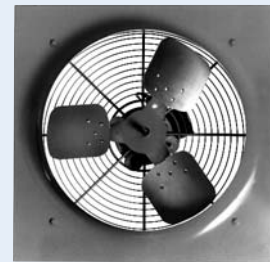

Model LYDK

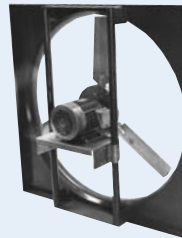

Model LNDA

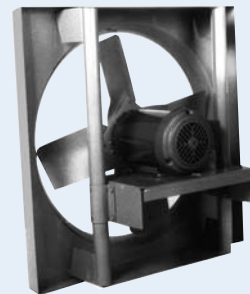

Model LJDB

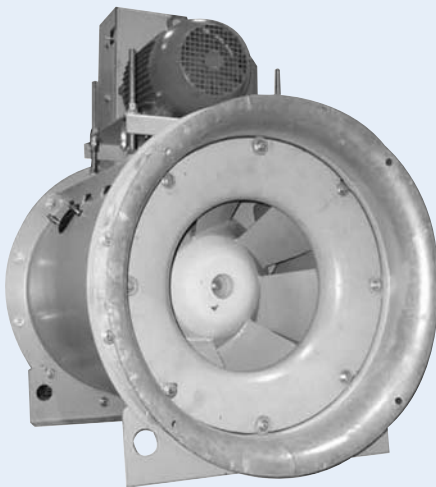

MIXED FLOW FANS

Carnes Mix Flow Fans consist of the latest design, the Mix Flow Fan is designed to save money as well as energy to the user. Our Mix Flow Fans are acoustically tuned to operate at a much lower sound levels than other in-line centrifugal and tubeaxial fans. Increased efficiency and lower operating speeds are the key components to delivering a great performing fan. Product standardization and production efficiency have made it possible to offer this advanced fan very economically in standard sizes. Along with each standard unit there are many accessory options to meet your specific design needs.

Air Movement Products

LOUVERS AND PENTHOUSES

Carnes offers a full line of extruded aluminum and galvanized louvers and penthouses. "J" blade, drainable blade, sight proof, wind driven rain and hurricane louvers are available in a variety of depths, in both stationary and adjustable blade designs. Anodized, baked enamel and kynar finishes are available on all louver models, in standard or custom colors to match every application.

Penthouses are available in mitered corner, post corner and drainable blade construction, with 4" deep louver walls. Mill finish is standard. Optional anodized, baked enamel and kynar finishes are also available.



Model FPBB

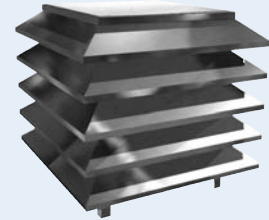

Model PMAB



DAMPERS

Carnes offers a wide variety of gravity and motorized dampers. Backdraft dampers, motorized dampers, control dampers and gravity and motorized round damper models are available. Many damper models have optional corrosion resistant finished available, and two position actuators in a wide variety of voltages.

FIRE DAMPERS

Carnes fire dampers are UL 555 listed, ULC S112 listed and State of California Fire Marshall listed. Type A, B or C construction is available. A variety of blade designs are also available, including curtain blade, crimped (3V) blade, airfoil blade, slimline design and true round.

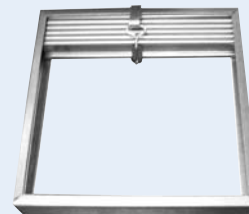

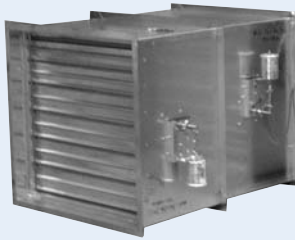

FIRE/SMOKE DAMPERS

Combination fire/smoke dampers are designed to prevent the passage of both flame and smoke, to be installed at locations that are designed as both fire barriers and smoke barriers. Carnes combination dampers comply with both the Standard for Fire Dampers, UL 555 and the Standard for Smoke Dampers, UL 555S.

Class I and II leakage ratings are available in a variety of blade constructions, including 3V blade, airfoil blade, true round and front (grille) access.

SMOKE DAMPERS

Carnes smoke dampers are UL 555S listed, ULC S112.1 listed and State of California Fire Marshall listed. Smoke dampers can be used in HVAC systems where the fans shut down in the event of a fire, and can also be used in smoke control systems designed to operate during a fire.

Class I and II leakage ratings are available on all Carnes smoke dampers. Blade designs include crimped (3V) blade, airfoil blade and true round.

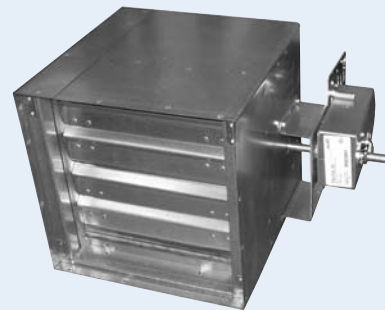

CEILING RADIATION DAMPERS

Carnes ceiling radiation dampers meet all NFPA 90A, IBC Code, and all other major code requirements for ceiling radiation dampers. Butterfly blade, fabric blade and hinged door type blade designs are available, as well as slimline designs. Thermal blanket skirts and square, rectangular or round transitions are available on most damper models.

Air Conditioning Products

CARNES ENERGY RECOVERY

Carnes, a leader in providing HVAC solutions, recognized over 40 years ago that energy conservation and equipment efficiency via Energy Recovery is key to providing acceptable indoor air quality through outside air ventilation. A pioneer of Energy Recovery Wheels, no other manufacturer can boast a record of over 43 years of continuously providing Energy Recovery solutions to the commercial work place. Carnes utilizes highly efficient 3 angstrom molecular sieve desiccant with integral corrosion protection. No media or desiccant used in Energy Recovery today has the track record of results and performance that Carnes has.

BENEFITS OF ENERGY RECOVERY TECHNOLOGY:

- Immediate and daily dollar savings: reduce cost to condition outside air up to 80% by recovering **sensible** and **latent** exhaust air energy.
- Reduce investment by downsizing required cooling capacity.
- Enthalpy recovery increases cooling recovery up to 300% with latent recovery.
- Cost effectively aids in meeting ASHRAE 62 ventilation guidelines.
- Complies with ASHRAE 90.1 energy guidelines requiring energy recovery.
- Carnes Energy-C-Lect Performance Software makes choosing the optimal solution time and cost effective.

Now AHRI 1060 Certified!



300 to
8,000 CFM

Model WE

Model WE Energy Recovery Ventilators provide affordable outside ventilation by combining an exhaust fan, make-up air handler, and Carnes Energy Recovery Wheel into a compact package that minimizes capital investment and maximizes payback for heating and cooling equipment. Units available for both inside and outside mounting.

BENEFITS:

- Low investment with maximum payback.
- Easy to use in new construction or renovation.
- Flexible, convenient installation and startup.

Model WP “Core” type Energy Recovery Ventilators. Now you can offer HRV's with Energy Recovery cores optimized for cold climates, and ERV's for all climates with fewer moving parts.

- Low profile sizes for airflows 250 CFM to 4,500 CFM.
- Indoor and outdoor models.
- Core options:
 - High efficiency enthalpy cores for humidity recovery.
 - Aluminum sensible only cores for optimized recovery in cold climates.
 - Complete air stream separation.
 - Reduced maintenance from no moving parts.
 - Complete control options.
 - 10 year core warranty.
 - 2 year unit warranty.

Now AHRI 1060 Certified!



250 to
4,500 CFM

Model WP

Now AHRI 1060 Certified!



850 to
11,000 CFM

Model WM

Carnes Model WM Energy Recovery Mini Systems provide affordable preconditioned ventilation air, flexible design, and offers supplemental heating or cooling.

BENEFITS:

- Full Energy Recovery Wheel benefits from enthalpy media.
- Optional supplemental conditioning in a painted steel cabinet.
- 6 standard duct arrangements, special configurations available.
- Latched and hinged double wall access doors.

CARNES HUMIDIFICATION PRODUCTS

CARNES Electronically Controlled Steam Humidifiers use ordinary untreated tap water and convert it to mineral free steam for humidity control in commercial, industrial and institutional applications.

- ECONOMICAL**
- Disposable Cylinders Eliminate Periodic Maintenance for Reduced Maintenance Costs
 - Fast and Easy Installation
 - Reliable Electronic Components for Long Life
- EFFICIENT**
- Circuit Board Utilizes Microprocessor to Maximize Energy Conservation
 - Exclusive Circuit Board Design Eliminates Need for Internal Fusing
 - Large Selection of Humidity Control Features and Compatibilities
- VERSATILE**
- Standard Digital LCD Display and Diagnostic Functions to Simplify Maintenance
 - Capacities from 5 to 200 Pounds of Steam Per Hour
 - Optional Internal Circuit Breaker Protection
 - Various Methods of Steam Dispersion



5 Day



Models HB/HC

ELECTRONICALLY CONTROLLED HUMIDIFIERS

Carnes high efficiency electronically controlled humidifiers are designed to solve humidification problems encountered in offices, computer rooms, health care facilities and a wide variety of manufacturing processes. The units are controlled by an advanced solid state circuit board and are completely prepped and prewired for ease of installation. Carnes humidifiers generate steam from ordinary tap water using disposable plastic cylinders for low cost maintenance. A complete range of models is available with steam output rates from 5 to 200 pounds per hour.



Quality Built Products Since 1939

Vents & Fans



VAV Terminals



Registers, Grilles & Diffusers

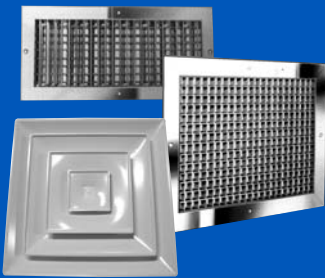

Louvers & Penthouses

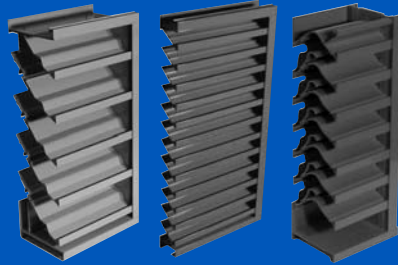

Energy Recovery



Fire & Smoke Dampers



Humidifiers



MEMBER



CARNES®

448 South Main Street
P.O. Box 930040
Verona, WI 53593-0040
Ph: 608-845-6411
Fax: 608-845-6504
Email: carnes@carnes.com

WWW.CARNES.COM