

CARNES COMPANY 448 S. Main St., P. O. Box 930040, Verona, WI 53593-0040 Phone: (608)845-6411 Fax: (608)845-6504 www.carnes.com

NOTES:

1. Observe proper polarity when using voltage or current devices.
2. If airflow and high limit switches are not used, a jumper must be installed.

————— By Carnes
- - - - - By Others

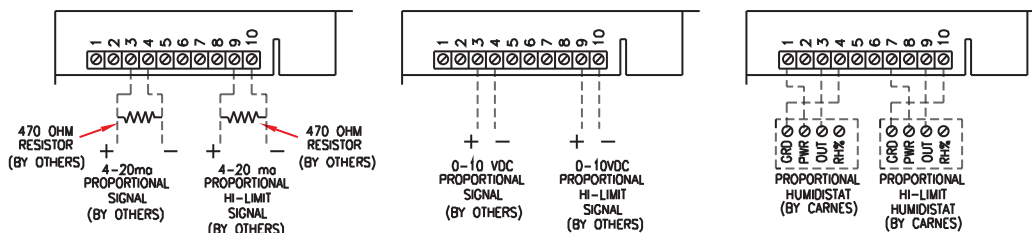
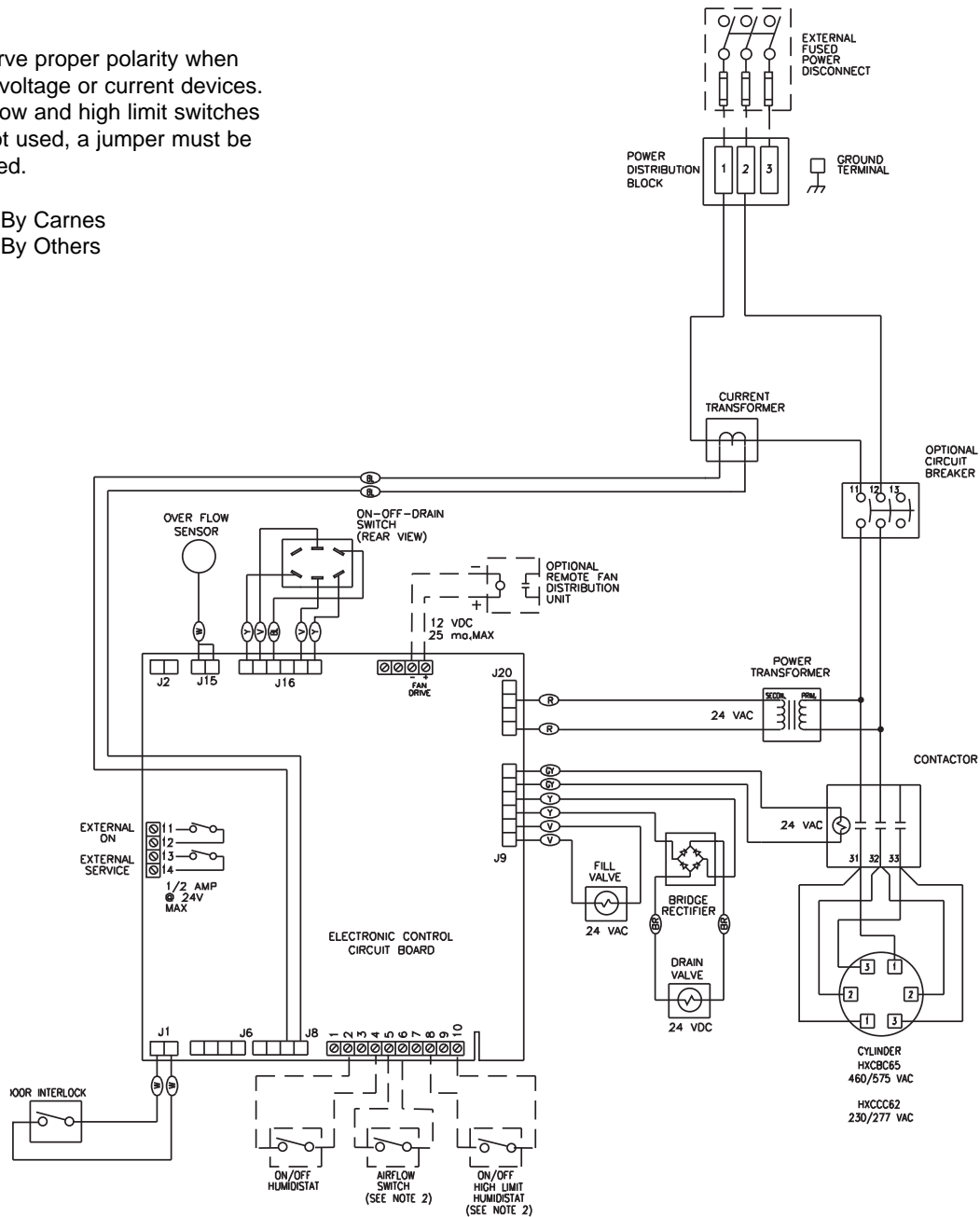

OPTIONAL
PROPORTIONAL
CONTROLS